

www.adrianierossi.com



SCARICA  
IL CATALOGO  
ATELIER VOLUME 2  
Download ATELIER  
catalogue volume 2

Adriani & Rossi studia lo spazio e realizza allestimenti per showroom, negozi di arredamento, spazi fieristici ed espositivi; cura la realizzazione dell'arredo dall'ideazione e progettazione grafica del mobile, con una particolare attenzione allo sviluppo del layout nella distribuzione del mobile.

Adriani & Rossi studies the space and creates preparations for showrooms, furniture stores, trade fair and exhibition areas; it prepares the furnishings, from development to graphic design of the furniture, with particular attention to the development of the layout in its distribution.



**Adriani e Rossi Edizioni S.r.l.**  
Sede Operativa ed Uffici / Headquarter

Via Marco Corner, 1  
36016 Thiene (VI) Italy  
Tel.: +39 0445.371131  
Fax: +39 0445.371132  
Web: [www.adrianierossi.com](http://www.adrianierossi.com)  
Shop: [shop.adrianierossi.com](http://shop.adrianierossi.com)

Per ordini inviare a / Orders sent to:  
Ufficio spedizioni e Magazzino / Warehouse

Via Domenico Morosini, 2  
36016 THIENE (VI) Italy  
Tel.: +39 0445.367776  
Fax: +39 0445.376448  
E-mail: (Italia) [oggetti@adrianierossi.com](mailto:oggetti@adrianierossi.com)  
E-mail: (world) [export@adrianierossi.com](mailto:export@adrianierossi.com)

Prezzi IVA esclusa. Franco fabbrica.  
Vat excluded prices. Ex factory.

Copyright © Adriani & Rossi Edizioni (Italia)

ADRIANI & ROSSI  
DISCOVER YOUR GENIUS



Atelier collezione volume 2 / OBJECTS MISS MARY PASSEPARTOUT

100% ITALIA

100% ITALIA

ATELIER

## Atelier collezione volume 2

OBJECTS

MISS MARY

PASSEPARTOUT



ADRIANI & ROSSI®  
DISCOVER YOUR GENIUS

SHOP.ADRIANIEROSI.COM



ADRIANI & ROSSI®  
DISCOVER YOUR GENIUS

OBJECTS

MISS MARY

PASSEPARTOUT

ADRIANI & ROSSI®  
DISCOVER YOUR GENIUS



## ATELIER

**Atelier** è uno stile. Un insieme di lampade, ceramiche, vetri, quadri e tappeti pensato per creare interior, emozioni all'arredamento. Interamente prodotti in Italia nella qualità e nelle finiture di maestri d'Arte. **Atelier** is a style. A set of lamps, ceramics, glass, paintings and rugs designed to create interior, emotions on the interior design. Entirely produced in Italy in the quality and in the finishing of the Art masters.

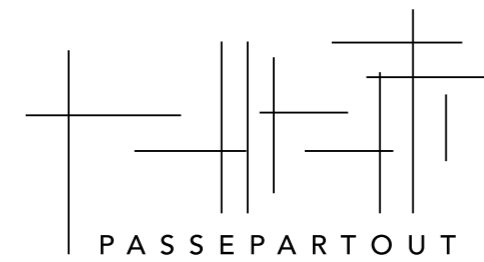

PASSEPARTOUT

**Passepartout** è un'insieme di complementi pronti all'uso in metallo dallo spessore 1 cm verniciati antracite. Vero design minimale in molteplici forme e funzioni. **Passepartout** is a collection of furniture ready to use in metal thickness 1 cm lacquered anthracite. Real minimal design in different shapes and functions.



**Miss Mary Design** è un concept che trasforma gli arredi in vere sculture. Un mobile scolpito a mano che ripete nei volumi la venatura del legno. Brevetto di invenzione di ADRIANI & ROSSI. **Miss Mary Design** is a concept that transform the furniture in real sculptures. A handmade carved furniture that repeats in the volumes the wood grain. Patented item of ADRIANI & ROSSI.

### ADRIANI & ROSSI COLLECTIONS



Atelier



Objects



Wallpaper

Entra nel sito internet e scarica tutte le collezioni Adriani e Rossi nella sezione "CATALOGHI". Enter the website and download all Adriani & Rossi collections in the "Catalogs" section.



Adriani & Rossi supports: I BAMBINI DELLE FATE per l'infanzia italiana



ADI XXII (2011) Compasso d'Oro - Menzione d'onore - Honorable Mention

# PASSEPARTOUT UN SEGNO CHE DISEGNA LO SPAZIO

PASSEPARTOUT A SIGN THAT DESIGN THE SPACE



LA COLLEZIONE PASSEPARTOUT È UN'INSIEME DI COMPLEMENTI  
CON STRUTTURA IN METALLO SPESSORE 1 CM.  
THE PASSEPARTOUT COLLECTION IS A SERIES OF FURNITURE WITH  
METALLIC STRUCTURE THCK 1 CM.

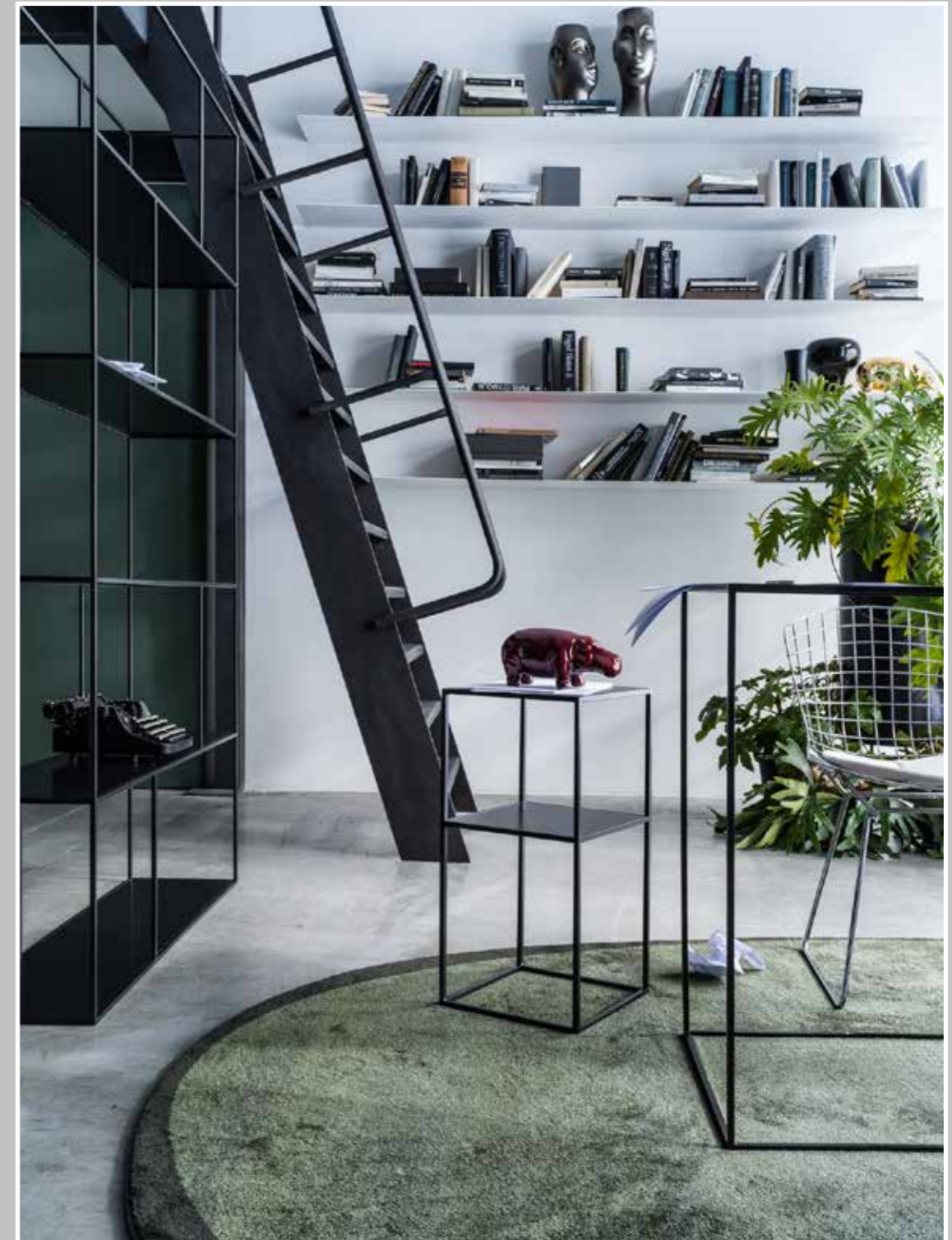
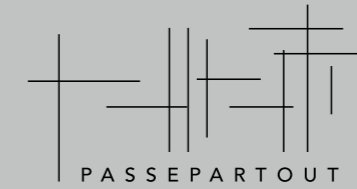

 **Segno**  
Mensole in metallo  
Metal shelves  
Pag. 267

 **Desk PASC160X470**  
Scrivania in metallo  
Metal desk  
Pag. 267

 **Libreria 80 PALI80X690**  
Libreria in metallo  
Metal bookcase  
Pag. 267

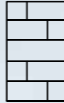
 **Libreria 120 PALI120X795**  
Libreria in metallo  
Metal bookcase.  
Pag. 267

 **Lovac S162X800**  
Tappeto ovale  
Oval shape rug  
Pag. 264



# LE GEOMETRIE SI INSEGUONO IN TUTTI I DETTAGLI

THE GEOMETRY CHASE ALL THE DETAILS

La pannellatura verticale serve a coprire nell'uso a muro i fili e le prese elettriche, il cassetto (a richiesta) è posizionabile a piacere perché magnetico.

The vertical boarding is needed to hide the electric wire and the socket in the wall, the drawer (un request) is placed as you prefer as it is magnetic.



Scrivania Desk collezione Passepartout. Desk Passepartout collection. Pag. 267

**LO SCRITTOIO È  
STRUTTURATO CON  
ELEMENTI DA 1 x 1cm  
ANCHE SUL PIANO DI  
LAVORO RITROVIAMO  
IL SEGNO DEL DETTAGLIO.**

THE DESK IS MADE WITH  
ELEMENTS 1 x 1 cm EVEN  
IN THE WORK TABLE  
WE CAN FIND THE SIGN  
OF THE DETAILS.



## CASSETTO MAGNETICO "MAGIC"

"MAGIC"  
MAGNETIC DRAWER



**Desk PASC160X470**  
Scrivania in metallo  
Metal desk  
Pag. 267



**Magic PACM30X80**  
Cassetto magnetico  
Magnetic drawer  
Pag. 267



**Ambrella D188X220**  
Fioriera in metallo  
Metal flowerpot  
Pag. 267



### QUESTIONE DI STILE QUESTION OF STYLE

Un gusto raffinato dove abbinare diventa un unico stile. La fioriera **Ambrella** diventa vaso portaombrelli e i colori del nero opaco si mescolano al paralume nero lucido della lampada **Danish** alle finiture cromate o al vaso **Pongo** in vetro soffiato di Murano. A sophisticated taste that matches in an unique style. The planter **Ambrella** becomes umbrella stand the matt black colors melt with the black shiny lampshade of the **Danish** lamp and with the chromed finishing or with the **Pongo** vase Murano blown glass.



**Danish table P459X172**  
Lampada da tavolo  
Table lamp  
Pag. 238



**Pongo C178X100**  
Vaso in vetro  
Glass vase  
Pag. 248



**Pongo C179X150**  
Vaso in vetro  
Glass vase  
Pag. 248



**Vaso Pongo. Pongo vase. Pag. 248**

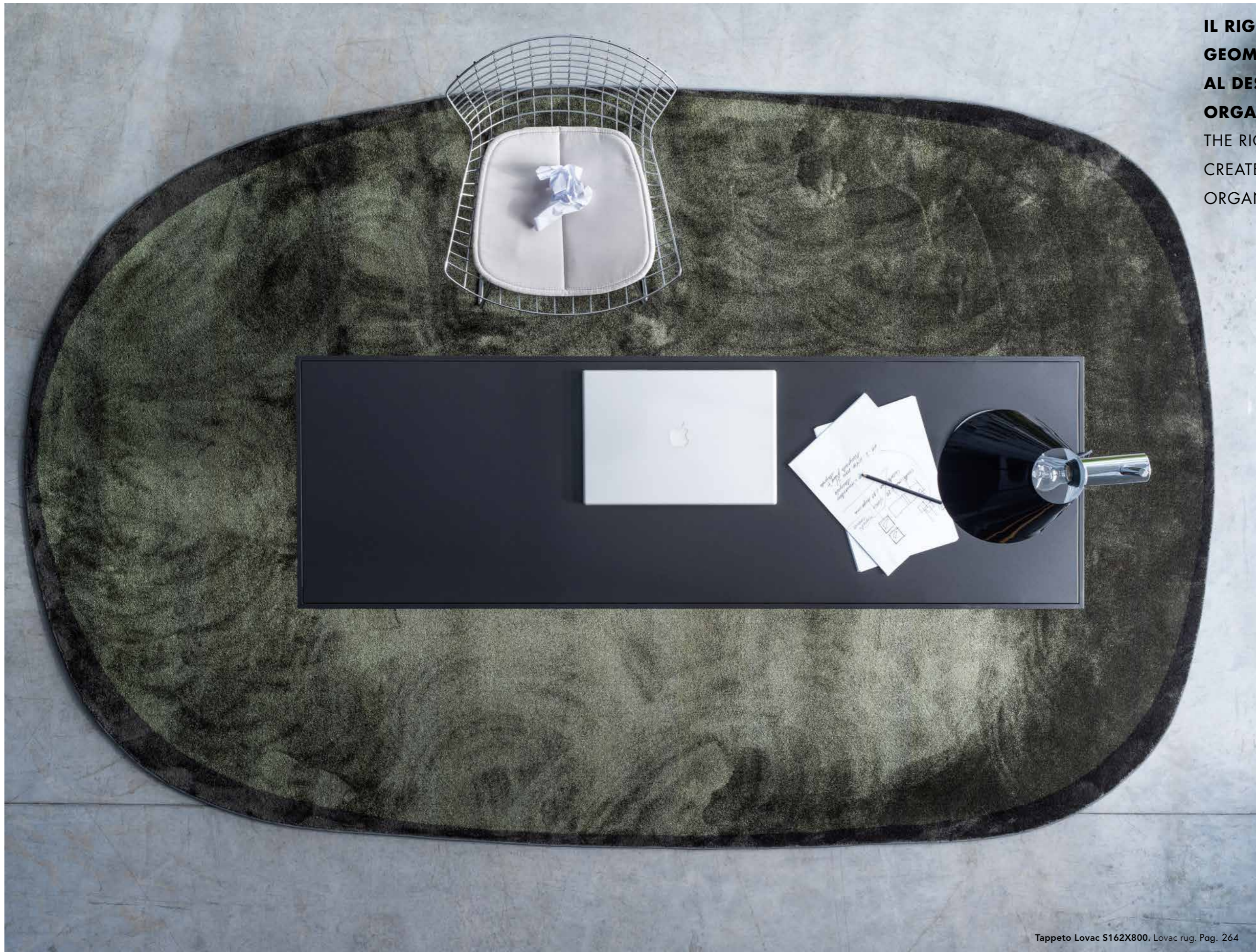

**IL RIGORE DELLA  
GEOMETRIA CREA SPAZIO  
AL DESIGN DALLE FORME  
ORGANICHE.**

THE RIGOR OF THE GEOMETRY  
CREATES SPACE ON THE  
ORGANIC DESIGN.

Tappeto **Lovac** in  
poliammide soft nialon  
nella sfumatura degradè  
con bordo decorato in tinta.  
The **Lovac** polyamide soft  
nylon rug in the shaded colors  
with border matching with the  
color of the rug.

Tappeto Lovac S162X800. Lovac rug. Pag. 264



Tappeto Boss S137X450. Boss rug. Pag. 262

### COORDINATI SPECIALI SPECIAL MATCHING

Le collezioni di tappeti ADRIANI & ROSSI sono pensate per essere coordinate ai complementi e agli oggetti. Materiali evoluti dal design senza tempo. Sopra, tappeto **Boss** in viscosa Tencel rasato con geometrie a quadrattino a rilievo. Disponibile nei colori perla e grigio. A destra tappeto **Lovac** nella versione degradè grigio. The rug collection of ADRIANI & ROSSI are designed to match the furniture and the objects. Evolved materials timeless design. **Boss** viscose tencel rug with square geometry. Available in the colors pearl or grey, On the right **Lovac** rug in the shaded grey color.



LOVAC  
GEOMETRIA  
ORGANICA  
LOVAC ORGANIC GEOMETRY

Tappeto Lovac S162X800. Lovac rug. Pag. 264



# IL SEGNO DI DESIGN

## THE SIGN OF DESIGN

Mensola **Segno** pensata come segno leggero e design minimale, per mettere in evidenza e sospensione gli oggetti. La cover di copertura ai sistemi di fissaggio rende semplicissimo il montaggio. **Segno** shelf is designed as light sign, minimal design, to underline and point out the objects. The cover that covers the fixing system make the installation very simple.



# LINEE ESSENZIALI MORBIDE EFFUSIONI DI LUCE

ESSENTIAL LINES AND SOFT EFFUSION OF LIGHT



Lampada Flou. Flou lamp. Pag. 236



Lampada applique Window P457X310.  
Window applique lamp.  
Pag. 239

Nella foto lampada applique **Window** in finitura antracite, mensole **Segno** in finitura antracite, ranocchio **Prince** in finitura bianco opaco e coroncina oro 24 carati. In the picture wall lamp **Window** anthracite finishing, shelf **Segno** anthracite finishing, frog **Price** matt white finishing with crown 24 carat gold.

# OGGETTI D'ARTE

## OBJECTS OF ART

Collezione **Orizzonte** in porcellana con pitture eseguite a mano.

Centrotavola **Sally**, vaso monofiore **Punto**, vaso cilindro **Fossil**, vaso alto **Strato**, vaso **Linea**.

*Orizzonte collection porcelain with handmade decorations.*

*Sally centerpiece, Punto vase, cylinder vase Fossil, high vase Strato, Linea vase.*

Pag. 242



Sally Q489X85  
Ø 42 cm

Punto Q488X70  
Ø 9 H 34 cm

Linea Q486X110  
Ø 13,5 H 48 cm

Strato Q485X126  
Ø 12 H 78 cm

Fossil Q487X110  
Ø 13,5 H 48 cm

# MORBIDE RIFLESSIONI DEL CERCHIO O DELL'ELLISSE

LIGHT REFLECTIONS OF THE CIRCLE OR OF THE ELLIPSE



## PLANETA



Lampada da tavolo Planeta P463X220. Planeta table lamp. Pag. 260  
Comodino Como. Como bedside table. Pag. 266

Comodino **Como**, collezione **Passepartout**. Le specchiere **Planeta** con luce Led, vetro fumè e struttura in MDF laccato opaco non hanno elementi di montaggio a vista. Usale anche come applique luminose o se preferisci utilizzarle come semplici specchi scegli la versione senza luce, il loro nome è **Vip mirror**.

Como bedside table, **Passepartout** collection. The mirror **Planeta** with Led light, fumé glass mdf lacquered matt structure no element for installation at sight. Use them also as luminous applique or if you prefer use them as simple mirrors choose the version without light, their name is **Vip mirror**.



# MAGICO PIACERE

MAGIC PLEASURE

Lampada Follow me P468X180. Follow me lamp. Pag. 241

## LAMPADA FOLLOW ME FOLLOW ME LAMP



La lampada in metallo **Follow me** è ricaricabile con luce a led. Ti segue ovunque vuoi e può essere usata anche in ambienti outdoor l'effetto luminoso consigliato per ambienti restaurant. La base magnetica può essere utilizzata per fissarla su superfici metalliche ovunque si desidera. Abbinata alla collezione **Passepartout** crea design e bellezza. The metallic lamp **Follow me** is rechargeable with led light. It follows you everywhere and it can be used also in outdoor area, the light effect suggested for restaurant areas. The magnetic base can be used to fix it in metallic surfaces everywhere you like. With the **Passepartout** collection it creates beauty and design.



## "MAGIC" CASSETTI MAGNETICI MAGNETIC DRAWERS

Posiziona quanti cassetti vuoi, dove vuoi, nelle librerie, nelle consolle o nelle mensole. Facilissimi all'uso, diventano pratici e disegnano il mobile a tuo piacere.

Use how many drawers as you want, where you want, in the library, in the console or in the shelves.

Easy to use, handy they design the furniture as you prefer.

Cassetto Magic PACM30X80. Magic drawer. Pag. 267



Habibi Q404/3X82 Amal Q405/3X82 Pag. 245

### HABIBI E AMAL, ICONE IMMOBILI

HABIBI AND AMAL, STILL ICON

Vasi scultura **Habibi** e **Amal** disponibili in varie finiture, la ceramica è all'interno smaltata per l'uso di acqua. Pouf **Nappe** in gres porcellanato in finitura antracite.

**Habibi** and **Amal** sculpture vases available in different finishing, the ceramic is inside lacquered suitable for the use of water. **Nappe Pouff** stoneware anthracite finishing.

 **Passade Q211/8X124**  
Vaso in ceramica  
Ceramic vase  
Pag. 242

 **Passade Q212/8X124**  
Vaso in ceramica  
Ceramic vase  
Pag. 242

 **Passade Q209/8X124**  
Vaso in ceramica  
Ceramic vase  
Pag. 242

 **Passade Q208/8X142**  
Vaso in ceramica  
Ceramic vase  
Pag. 242

 **Cherry Q280/2X160**  
Scultura in ceramica  
Ceramic sculpture  
Pag. 244

 **Madia 80 PALI30X384**  
Libreria in metallo.  
Metal bookcase.  
Pag. 267

 **Libreria 80 PALI80X690**  
Libreria in metallo.  
Metal bookcase.  
Pag. 267

 **Libreria 120 PALI120X795**  
Libreria in metallo.  
Metal bookcase.  
Pag. 267







Insieme di ceramiche e vetri **Passade** Collection nero opaco, vaso monofiore **Bamboo** nero opaco. Vaso **Venissa** in ceramica nero con lavorazioni a sbalzo, vaso **Pongo** in vetro di Murano fumè e portagioie **Passade** collection nero opaco e platino oxyd anticato. Collection of ceramics and glass, **Passade** Collection matt black color, one flower **Bamboo** vase matt black. Ceramic vase **Venissa** matt black embossed finishing, **Pongo** Murano glass vase fumè finishing and jewel case, **Passade** collection matt black and oxyd finishing antique platinum.



#### LA QUALITÀ NELLA BELLEZZA THE QUALITY IN THE BEAUTY

Dettaglio della finitura Oxyd platino anticato, un'antica lavorazione della ceramica di Bassano del Grappa dove il platino viene antichizzato a fuoco in alta temperatura rendendo l'oggetto con un effetto sbalzato e crea inediti riflessi. Details of the oxyd finishing in antique platinum this is an ancient manufacturing of the Bassano del Grappa ceramics, the platinum passes through the high temperature of the fire making the objects with an emboss effect and it creates unique reflections.



Pouf **Nappe**. Nappe Pouf. Pag. 272

Comodino **Como**. Como bedside table. Pag. 266

Pouf **Nappe** in finitura gres porcellanato, consolle **Tulip 60** collezione **Passepartout**, tappeto **Klee**. Qui sotto vasi **Tob** in finitura bronzo rigato. Pouff **Nappe** stoneware, consolle **Tulip 60** Passepartout collection, **Klee** rug. Here below **Tob** vases ridged bronze color.



Vaso **Tob**. Tob vase. Pag. 246

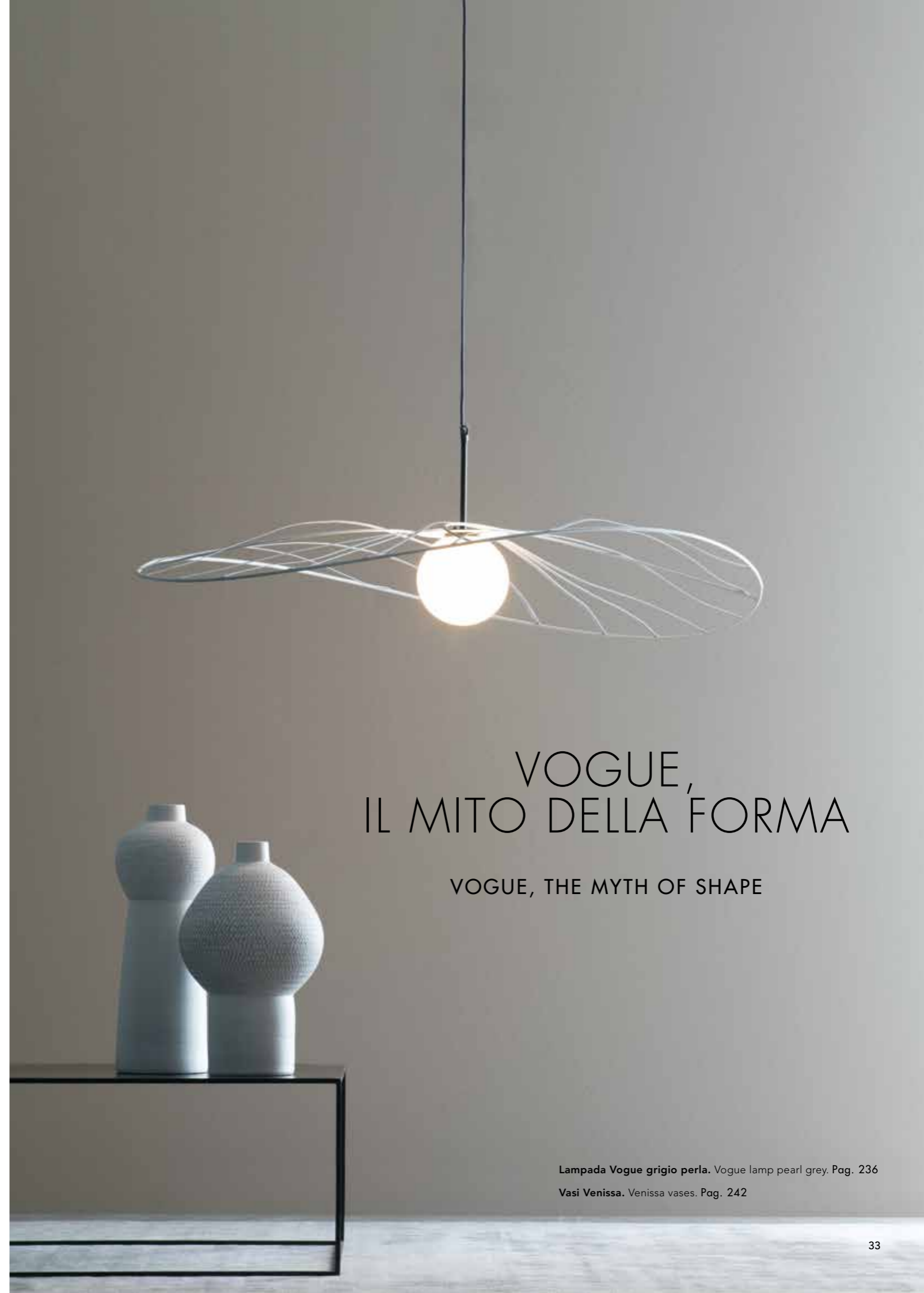

# VOGUE, IL MITO DELLA FORMA

VOGUE, THE MYTH OF SHAPE

Lampada **Vogue grigio perla**. Vogue lamp pearl grey. Pag. 236

Vasi **Venissa**. Venissa vases. Pag. 242

# FUSIONE DI STILE

FUSION OF STYLE

 **Toby Bronze P448X98**  
Lampada a sospensione  
Hanging metallic lamp  
Pag. 241

 **Tulip PATU80X168**  
Consolle in metallo  
Metal console  
Pag. 268

 **Boule C206BX220**  
Vaso in vetro  
Glass vase  
Pag. 251

 **Nappe Q497X90**  
Pouff in gres porcellanato  
Pouf in porcelain stoneware  
Pag. 272

 **Lovac S162X800**  
Tappeto ovale  
Oval shape rug  
Pag. 264



 **Ambrella D188X220**  
Portaombrelli in metallo  
Metal umbrella stand  
Pag. 267

 **Murales F124MX150**  
Quadro materico  
Materic painting  
Pag. 257

 **Hippo Wagon Q452/6X300**  
Scultura in ceramica  
Ceramic sculpture  
Pag. 243



**TAPPETO KLEE RIPRENDE LINEE  
DI DECORO E DI CREATIVITÀ**

**KLEE RUG FOLLOWS DECORATIONS  
LINES AND CREATIVITY**

Le linee nel tappeto **Klee** si rincorrono e si intersecano in originale bellezza e fusione nella geometria di Passepourtout. The lines in the rug **Klee** run after each other and cross in original beauty and fusion in the geometry of Passepourtout.

Pag. 263

LINEE  
ESSENZIALI

ESSENTIAL LINES

Tappeto Klee S161X660. Klee rug. Pag. 263

# GEOMETRIE TRIDIMENSIONALI

THREE DIMENSIONAL GEOMETRY





 **Teca C205BX100**  
Teca in vetro  
Glass storage case  
Pag. 251

 **Tulip PATU30X145**  
Consolle in metallo  
Metal console  
Pag. 268

Trespole **Tulip** con teca portacandela, Quadro scultura luminosa **Amadeus** in finitura goldenblack.  
Perch **Tulip** with storage case for candle, sculpture luminous painting **Amadeus** golden black finishing.



 **Amadeus F159/6X260**  
Scultura a muro  
Wall sculpture  
Pag. 260

 **Cover C20AX18**  
Vaso in vetro  
Glass vase  
Pag. 268

 **Tulip vase 100 PATV100X265**  
Consolle in metallo  
Metal console  
Pag. 268

 **Lovac S162X800**  
Tappeto ovale  
Oval shape rug  
Pag. 264

 **Hippo Wagon Q452/6X300**  
Scultura in ceramica  
Ceramic sculpture  
Pag. 243



URBAN STYLE

Uno stile urban interpretato dalle finiture metalliche dei quadri **Museum** in metallo verniciato golden black con nicchia materica decorata in foglia oro 24 carati. Consolle **Tulip 80** della serie **Passepartout**. Tappeto **Line**.

A destra: lampada **Toby** Ø 2,5 H 30 cm con luce Led in metallo finitura bronzo o antracite.

Urban style interpreted in the metallic finishing of the **Museum** painting in metallic varnished golden black with materic lowrelief decorated in gold 24 carat leaf. Consolle **Tulip 80** from **Passepartout** collection. Rug **Line**.

On the right **Toby** lamp Ø 2,5 H 30 cm led light in metal finishing bronze or anthracite.



**Tulip 120 PATU120X238**  
Consolle in metallo  
Metal console  
Pag. 268



**Museum F138BX190**  
Quadro artistico in metallo  
Artistic metallic painting  
Pag. 258



**Line S28X320**  
Tappeto  
Rug  
Pag. 263

# FORME E COLORI DELLA METROPOLI

SHAPES AND COLORS OF THE METROPOLI

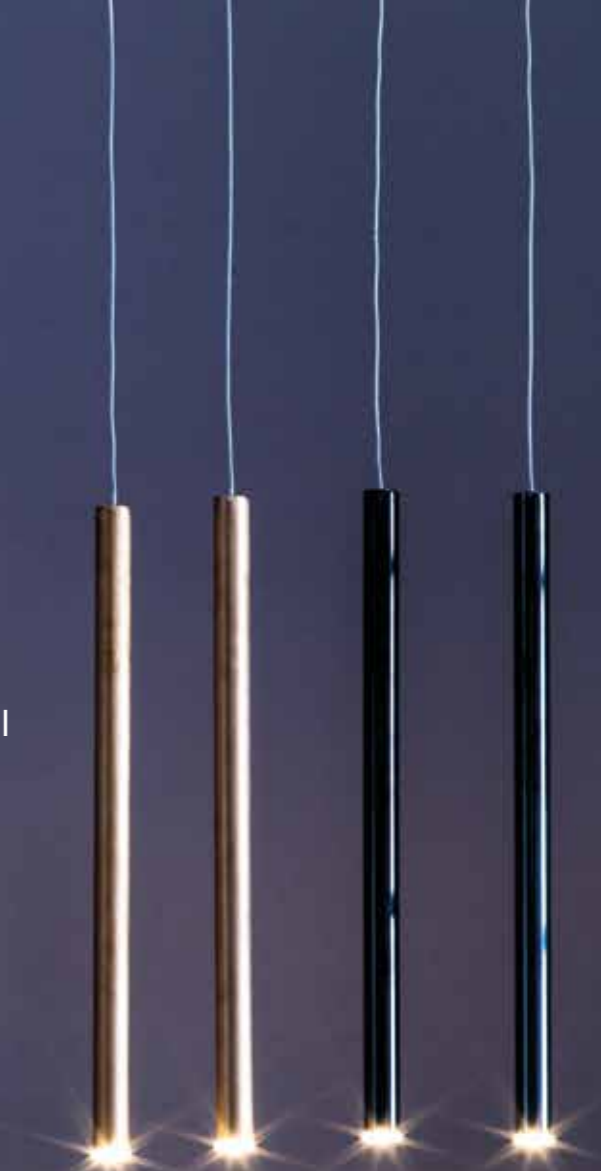

**Toby Bronzo P448X98**  
Lampada a sospensione  
Hanging metallic lamp  
Pag. 239

**Toby Nero P447X98**  
Lampada a sospensione  
Hanging metallic lamp  
Pag. 239



# DESIGN, ARTE, COLORE PER DIVERSE ISPIRAZIONI

DESIGN, ART, COLOR FOR DIFFERENT INSPIRATIONS



COMPLEMENTI COORDINATI NEI DECORI, NEI COLORI.

DIVERSI MATERIALI PER CREARE SCENOGRAFIE D'INTERNI.

FURNITURE COORDINATED IN THE DECORATION AND IN THE COLORS.

DIFFERENT MATERIALS TO CREATE INTERIOR SCENOGRAPHY.

## ATELIER



Vasi **Setus** e **Mito** con base in golden black. Tappeto **Amour** in ciniglia. Tavolino **Round**.

Quadri **Harmony** e **Oyster**.

**Setus** and **Mito** vases with golden black base. **Amour** chenille rug. Table **Round**.

Painting **Harmony** and **Oyster**.

# NEL SEGNO DELLA MODA E DEL DESIGN

IN THE NAME OF FASHION AND OF THE DESIGN



 **Mito Cross High C209X240**  
Vaso in vetro di Murano  
Murano glass vase  
Pag. 250

 **Setus Square High C210X240**  
Vaso in vetro di Murano  
Murano glass vase  
Pag. 250

 **Onda Q193/2X299**  
Vaso in ceramica smaltata oro 24 carati  
Vase ceramic glazed 24 carat gold  
Pag. 247





**HARMONY**  
 Quadro con fascia acciaio o ottone.  
 Painting with steel or brass band.  
 Pag. 252



**OYSTER**  
 Quadro con nicchia e bordo acciaio o ottone.  
 Painting with niche and edge in steel or brass.  
 Pag. 253

**UN SEGNO METALLICO**  
 A METALLIC SIGN

Serie di quadri materici effetto cemento, incorniciati in legno con cornice laccata nera opaca o golden black, rame, oro, con inserti in metallo bronzo, rame e acciaio. **Harmony** ha una fascia in metallo da 4 cm incavata sulla pittura, mentre **Oyster** ha un profilo da 5 mm che crea una doppia profondità al quadro.

Series of materic paintings concrete effect, wood frame lacquered matt black or golden black, copper, gold, with metallic insert copper, bronze and inox. **Harmony** has a 4 cm metallic stripe hollowed in the painting, **Oyster** has a 5mm profile that creates double profundity in the painting.



**Cover C20AX18**  
Vaso in vetro  
Glass vase  
Pag. 268



**Tulip Vase PATV30X155**  
Consolle in metallo  
Metal console  
Pag. 268



**Round PATR40X189**  
Tavolino in metallo  
Metal coffee table  
Pag. 266



**Libreria 120 PALI120X795**  
Libreria in metallo.  
Metal bookcase.  
Pag. 267



**Hippo Wagon Q452/2X380**  
Scultura in ceramica  
Ceramic sculpture  
Pag. 243



**Amour S163X460**  
Tappeto  
Rug  
Pag. 262







ATELIER - LA CURA DEL DETTAGLIO  
THE ATTENTION TO THE DETAIL

Coordinati nelle finiture e dal design, i vasi **Canaletto** in ceramica nelle finiture nero opaco e platino Oxyd anticato. La lampada **View** in metallo antracite opaco con sfera in vetro di Murano soffiato tortora. Ranocchio **Prince** e **Queen** in ceramica smaltata oro rosa con coroncina in oro 24 carati, vaso **Pera** in vetro soffiato. Tavolini **Bistrò Passepartout**. Coordinated in the finishing and in the design, the ceramic vases **Canaletto** in the finishing matt black, Oxyd antiqued platinum. The metallic lamp **View** in matt anthracite with Murano glass sphere in fume color. Frog **Prince** and **Queen** in glazed ceramic pink gold with crown in 24 carat gold, **Pera** vase in blown glass. **Bistrò Passepartout** table.

 **Canaletto Q296/3X46**  
Scultura in ceramica nero opaco  
Ceramic sculpture matt black  
Pag. 247

 **Canaletto Q296/8X70**  
Scultura in ceramica Oxyd platino anticato  
Oxyd antique platinum ceramic sculpture  
Pag. 247



 **View P441X280**  
Lampada a sospensione.  
Suspension lamp.  
Pag. 237

 **View P442X280**  
Lampada a sospensione.  
Suspension lamp.  
Pag. 237

 **Pera C36X185**  
Vaso in vetro.  
Glass vase.  
Pag. 251

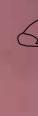
 **Queen Q495/8X85**  
Scultura in ceramica.  
Ceramic sculpture.  
Pag. 246

 **Prince Q496/8X85**  
Scultura in ceramica.  
Ceramic sculpture.  
Pag. 246



**Ellis F157X180**  
 Quadro ovale stampato  
 Printed oval painting  
 Pag. 255



**Rainbow S120X900**  
 Tappeto tondo stampato  
 Printed round rug  
 Pag. 264



**Quinta F158X300**  
 Separè stampato  
 Printed separè booth  
 Pag. 261



**Hippo Big**  
 Scultura in ceramica  
 Ceramic sculpture  
 Pag. 243



**Hippo Wagon**  
 Scultura in ceramica  
 Ceramic sculpture  
 Pag. 243





**Prince**  
 Scultura in ceramica  
 Ceramic sculpture  
 Pag. 246





 **Quinta F158X300**  
Separè stampato  
Printed separè booth  
Pag. 261

 **Hippo Wagon**  
Sculptura in ceramica  
Ceramic sculpture  
Pag. 243

 **Rainbow S120X900**  
Tappeto tondo stampato  
Printed round rug  
Pag. 264



**TOTAL LOOK - UNICI AL MONDO**  
UNIQUE IN THE WORLD

Atelier riassume la nostra capacità ed esperienza di creare progetto coordinato. Abbinando le nostre carte da parati (vedi nostri cataloghi Wallpaper) a un tappeto, un paralume, un quadro, un separè. Atelier summarize our ability and experience to create a coordinated project. We match our wallpapers (take a look on our Wallpaper catalogues) with a rug, a lampshade, a painting, a screen.

**Alcuni esempi di decoro coordinati.** Some example of coordinated graphics.



WP03087



WP08177

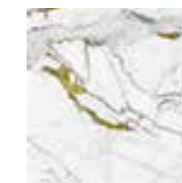

WP08147



WP07090



WP03092

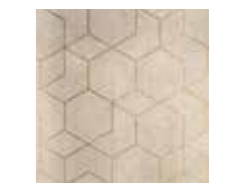

WP09013

**Scarica il catalogo  
Wallpaper vol. 03**  
Download the wallpaper  
catalogue vol. 03





**Hippo Mini Q451/2X60**  
Scultura in ceramica  
Ceramic sculpture  
Pag. 243



**Tulip PATU80X168**  
Consolle in metallo  
Metal console  
Pag. 268



**Madia 80 PALI30X384**  
Libreria in metallo  
Metal bookcase  
Pag. 267



**Libreria 80 PALI80X690**  
Libreria in metallo  
Metal bookcase  
Pag. 267



**Libreria 120 PALI120X795**  
Libreria in metallo  
Metal bookcase  
Pag. 267





IL VETRO SOFFIATO DI MURANO VENEZIA  
THE MURANO GLASS OF VENICE

I nostri maestri del vetro soffiato creano vere opere d'arte, ogni singolo pezzo avrà delle diversità perché unico e irripetibile. I vasi monofiore **Fagiolo** e **Pera** sono i must di ADRIANI & ROSSI creato nel 1994 e copiato in tutto il mondo. Our artisans of blown glass create real work of art, every single piece will look different as unique and exclusive. The vases **Fagiolo** and **Pera** are a must have of ADRIANI & ROSSI created in 1994 and reproduced all over the world.



**Fagiolo C37X215**  
Vaso in vetro  
Glass vase  
Pag. 251



**Pera C36X185**  
Vaso in vetro  
Glass vase  
Pag. 251



L'ARTE E LA TRADIZIONE  
DEI MAESTRI

**VETRAI VENEZIANI**

THE ART AND TRADITION  
OF THE MASTERS

VENETIANS GLAZIERS





Collezione vasi Sface. Sface collection vase. Pag. 243

ATELIER DI RICERCA  
ATELIER OF RESEARCH

Il decoro di **Sface**, vaso in ceramica con finitura in golden black lo ritroviamo come simbolo nel quadro scultura **Amadeus** disponibile con luce o senza luce, una particolare sfaccettatura che da tridimensionalità e urban style. The decoration of the vase **Sface**, ceramic vase in golden black finishing, we find it as a symbol in the sculpture painting Amadeus available with light or without light, a particular pattern that gives a three dimensional effect and Urban Style.





**EVOLUZIONE DELLA TRADIZIONE,  
PASSIONE PER IL DESIGN, TRASFORMARE  
ANTICHI DECORI IN EVOLUTI PROGETTI E  
SCENOGRAFIE D'INTERNI.**

EVOLUTION OF THE TRADITION, PASSION  
FOR THE DESIGN, TRANSFORM ANTIQUE  
DECORATIONS INTO EVOLVED PROJECTS AND  
INTERIOR SCENOGRAPHY.

Tappeto in ciniglia Amour. Amour chenille rug. Pag. 262



**Flou P434X290**  
Lampada in vetro di Murano  
Murano glass lamp  
Pag. 236



**Flou P433X290**  
Lampada in vetro di Murano  
Murano glass lamp  
Pag. 236



Collezione Passade. Passade collection. Pag. 242

### BORDEAUX MOOD

Bordeaux un classico nel colore oggi moda, un mood borghese che disegna nell'oggetto moderno un'evocazione al passato. La ceramica smaltata lucida a ricordo delle lacche orientali, trasformano le rotondità della collezione **Passade** Collection il bordeaux in sfumature rubino. A classic in the color bordeaux, today a fashion color, a bourgeois mood that design in the modern object a memory of the past. The glazed ceramic is a memory of the lacquering of the oriental varnish transforming the curves of the **Passade** Collection, the Bordeaux with ruby shades.

# PROGETTO COLORE

PROJECT COLOR

**MIX DI OGGETTI E SOLUZIONI STILI DIVERSI  
PER IL CONFORT DOMESTICO O PER GLI  
SPAZI COMUNI. L'INSIEME DI COMPLEMENTI  
SI ABBINA A LAMPADE, VASI,  
OGGETTI D'USO COMUNE**

MIX OF OBJECTS AND SOLUTIONS DIFFERENT  
STYLES FOR THE DOMESTIC CONFORT OR FOR  
THE PUBLIC AREAS. THE FURNITURE MATCHES  
WITH LAMPS, VASES, OBJECTS OF COMMON USE

## ATELIER



Lampada Babylon. Babylon lamp. Pag. 240

Tavolo Tulip 80 collezione Passepartout. Tulip 80 table Passepartout collection. Pag. 268

# PREZIOSE FINITURE IN RAFFINATE FORME

PRECIOUS FINISHING WITH SOPHISTICATED SHAPES

**PLATINO OXYD ANTICATO  
E NERO OPACO**  
OXYD FINISHING IN ANTIQUE  
PLATINUM AND MATT BLACK

Q209/8X124      Q211/3X52      Q208/8X142

Collezione *Passade*. *Passade* collection. Pag. 242

**ORIZZONTI  
DI PRESTIGIO**  
PRESTIGIOUS HORIZONS

Tob Big      Chic Small      Chic Big      Call      Canaletto      Tob Small      Sfera      Ovo big  
Q107/8X95      Q104/8X70      Q105/8X89      085/8X54      Q296/8X70      Q106/8X79      15T/8X45      Q125/8X70

Pag. 246 - 247



Guest pag. 249  
C203X39

Tob big pag. 246  
Q107/8X95

Venissa pag. 242  
Q482/6X50

Venissa pag. 242  
Q484/6X70

## EFFETTO METALLO SUPER STAR

METAL SUPERSTAR EFFECT

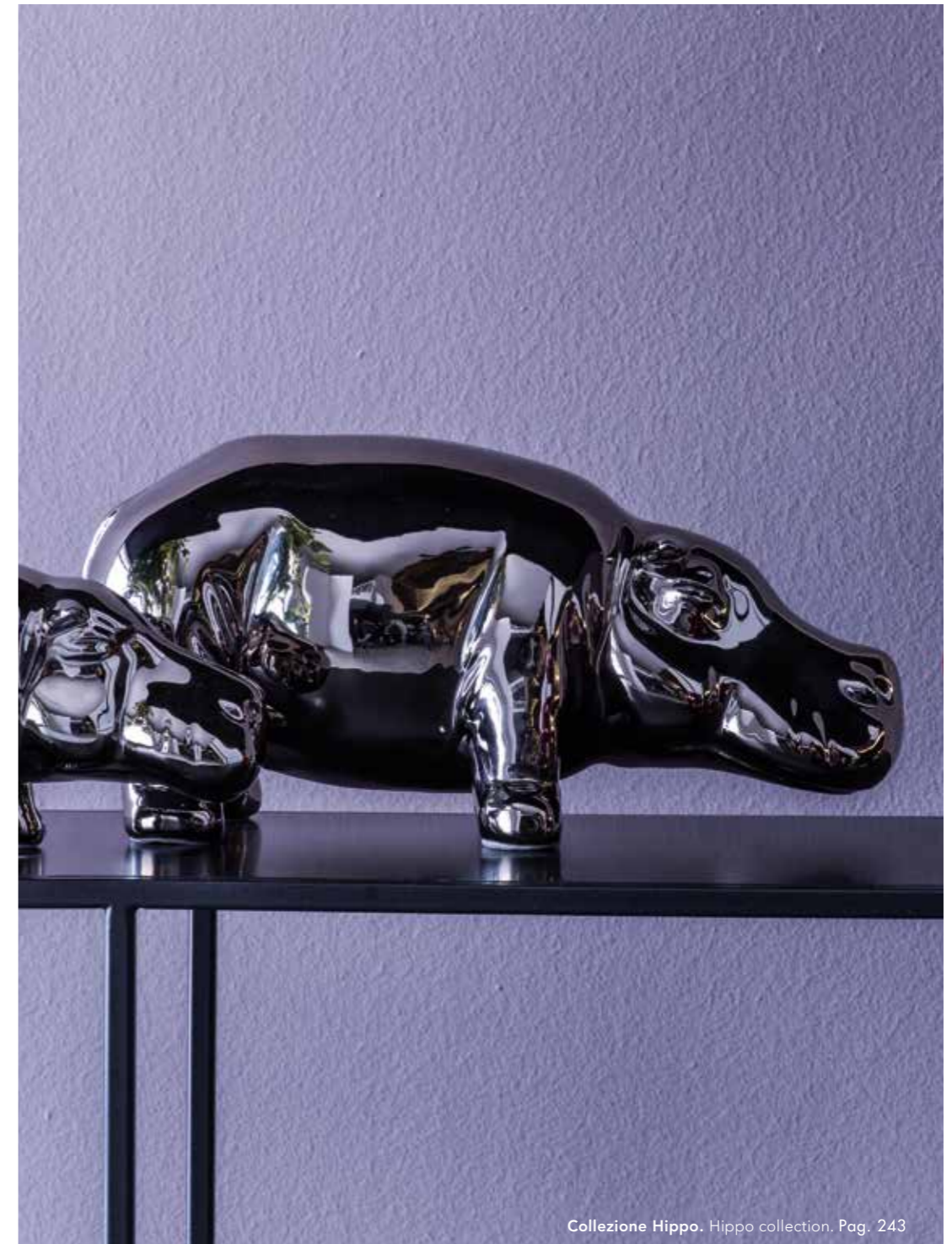

Collezione Hippo. Hippo collection. Pag. 243

### HIPPO

Qui sopra **Hippo** in platino lucente e avvolgente nelle sfumature. A sinistra vaso **Guest** in vetro brillante fumè. Vaso **Chic** in platino Oxyd anticato e vaso **Venissa** in finitura silver black. Above **Hippo** shiny platinum enchanting in the shades. On the left **Guest** vase in shiny fumè glass. **Chic** vase oxyd finishing antique platinum and **Venissa** vase silver black finishing.



Collezione Stone. Stone collection. Pag. 261



Hippo mini pag. 242  
Q451/2X60

Hippo Big pag. 242  
Q440/2X350



Hippo mini pag. 242  
Q451/2X60



Cherry floor big  
Q243/2X245

Collezione Cherry. Cherry collection. Pag. 244



Lampada da tavolo Caminia Gold P451X190. Caminia Gold table lamp. Pag. 241

LA MAGIA  
DELL'ORO,  
LUCENTE  
METALLICO  
DESIGN  
PREZIOSO

THE MAGIC OF GOLD,  
SHINY METAL PRECIOUS DESIGN



Buongiorno / Buonasera Pag. 245



Collezione quadri rotondi Giotto.  
Giotto round painting collection.  
Pag. 254

Lampada Babylon P367X120. Babylon lamp. Pag. 240



Q211/3X52  
Collezione Passade. Passade collection. Pag. 242

Tappeto Klee. Klee rug. Pag. 263

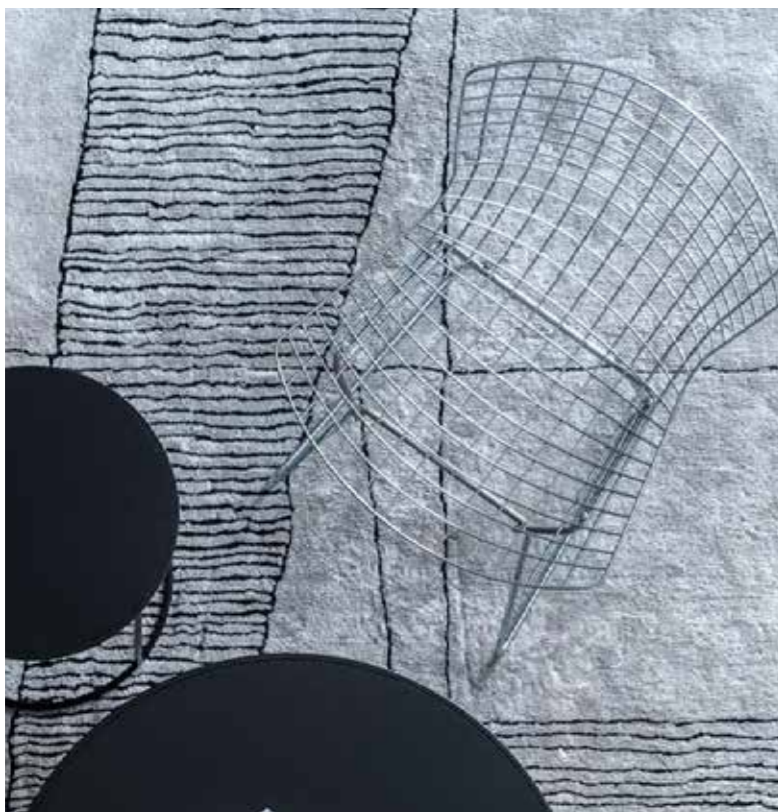

**LE SFUMATURE DEL  
NERO OPACO NEI  
QUADRI GIOTTO,  
NELLE COLLEZIONI DI  
CERAMICHE PASSADE, NEL  
TAPPETO KLEE**

THE SHADES OF THE MATT  
BLACK COLOR IN THE  
GIOTTO PAINTING, IN THE  
CERAMIC COLLECTION  
PASSADE, IN THE KLEE RUG

# SEXY SFUMATURE DEL NERO

SEXY BLACK SHADES



Centrotavola nero opaco Onda Pag. 247  
Onda matt black centerpiece  
Q193/2X299

Vaso monifiore Bamboo Pag. 242  
Bamboo flower vase  
Q491/3X50



Collezione vasi in vetro Absolute C200CX48 Absolute glass vases collection. Pag. 248



Collezione Stone. Stone collection. Pag. 261

Coordinati nelle sfumature del rosa il tappeto lucente **Ormus** in seta di bamboo. I vasi **Absolute** ametista, il sasso scultura a muro **Stone** nei colori desiderati e con la possibilità di kit luminoso. The pink shades matches the shiny rug **Ormus** silk bamboo. The amethyst **Absolute** vases, the sculpture wall **Stone** in the wanted colors with the possibility of light kit.



# AMETISTA ROSA ANTICO CIPRIA

AMETHYST, PINK GOLD, BLUSH PINK

Tappeto Ormus. Ormus rug. Pag. 264  
S159X660





Lord rosa pag. 251  
C191X150

Lord rosa pag. 251  
C190X125

Lord rosa pag. 251  
C192X180



Lampada da tavolo Caminia. Caminia table lamp. Pag. 241  
P450X180

VETRO OPALE  
OPAL GLASS

Antica lavorazione del vetro veneziano rosa sfumato, la lampada da tavolo **Camini**a si abbina ai vasi **Lord** dalle forme avvolgenti. Antique venetian glass manufacturing of the pink blown glass, table lamp **Camini**a matches with the **Lord** vases with enchanting shapes.

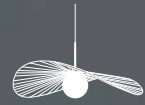

Vogue Plissé Small P445X320  
Lampada a sospensione  
Hanging lamp  
Pag. 236

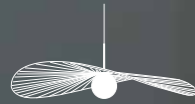

Vogue Plissé Big P446X540  
Lampada a sospensione  
Hanging lamp  
Pag. 236

## ICONA DI BELLEZZA

ICON OF BEAUTY

ATELIER

**LAMPADA PLISSY IN TESSUTO PLISSÈ MONTATO MANUALMENTE CON  
SFERA IN VETRO SOFFIATO DI MURANO. GRANDE SCENOGRAFIA AD  
EFFETTO VOGUE.**

LAMP PLISSY PLEATED WOVEN MANUALLY INSTALLED WITH SPHERE IN MURANO  
BLOWN GLASS. GREAT SCENOGRAPHY VOGUE EFFECT.





MODERN ART,  
SIMBOLO  
DI BELLEZZA

MODERN ART, SYMBOL OF BEAUTY



Collezione Stone golden black. Stone golden black collection. Pag. 261

**STONE IN VARIE FINITURE:  
PLATINO OXYD ANTICATO, GOLDEN  
BLACK E ORO 24 CARATI.  
SIMBOLO DI DECORO, ARTE E  
SCULTURA. DISPONIBILE ANCHE  
CON KIT DI ILLUMINAZIONE.**

STONE DIFFERENT FINISHING:  
OXYD FINISHING ANTIQUE PLATINUM,  
GOLDEN BLACK AND 24 CARAT GOLD.  
SYMBOL OF DECORATION, ART  
AND SCULPTURE.

AVAILABLE ALSO WITH LIGHT KIT.



Collezione Stone oro. Stone gold collection. Pag. 261



006M



009M



003M



002M



011M



020M



001M



027M



016M



017M



018M



024M



021M



023M



025M



013M



010M

**LE SCULTURE A MURO STONE DECORATE A MANO  
CON INTERVENTI IN FOGLIA ORO E FOGLIA ARGENTO  
CREANO GRANDE EFFETTO VISIVO,  
COLORE E VERA SCULTURA.**

WALL SCULPTURES STONE HANDMADE DECORATION SILVER  
LEAF OR GOLD LEAF CREATE GREAT VISUAL EFFECT, COLOR  
AND REAL SCULPTURE.



STONE ART  
COME UN  
GRANDE QUADRO

STONE ART  
LIKE A BIG PAINTING

**VASI PONGO**  
**IN FINITURA FUMÈ**  
PONGO VASES  
FUMÉ FINISHING



Vaso Pongo C178X100  
Pag. 248

Vaso Pongo C179X150  
Pag. 248

IL FASCINO  
DEL VETRO  
ELEGANTE  
FLUIDO  
VERSATILE

THE CHARM  
OF THE ELEGANT GLASS,  
FLUID, ECLECTIC

Vaso in vetro trasparente **Torch**  
e ranocchia **Queen**  
Transparent glass vase **Torch**  
and frog **Queen**



Vaso Torch C132AX32  
Pag. 248



Vaso **Gong** in vetro soffiato in finitura fumè. Una grande ampolla in vetro fumè soffiato crea una forma organica e geometrica allo stesso modo ancor più sorretta dal basamento in metallo antracite che ben si abbina alla collezione **Passepartout**.

**Gong** vase in glass fume finishing. A big ampule in fume glass vase creates an organic and geometric shape sustained by a metallic anthracite support which match with the **Passepartout** collection.



**Gong C208X80**  
Vaso in vetro fumè con base in metallo  
Grey glass vase with metal base  
Pag. 249



**Eloise C207AX34**  
Vaso in vetro fumè  
Grey glass vase  
Pag. 248



**Eloise C207BX46**  
Vaso in vetro fumè  
Grey glass vase  
Pag. 248

# ARMONIE PER VISIONI ESTETICHE

ARMONY FOR AESTETICH VIEWS



Vaso fumè **Eloise**  
Coffee table **Como e Round**  
Separè **Quinta**  
tappeto **Land** grigio  
Eloise vase fumé finishing  
Coffee table **Como and Round**  
Quinta separè booth  
Land grey rug



Lampada da tavolo Dizzi P440X200  
Dizzi table lamp. Pag. 241

Rigore e ricercatezza negli spazi, forme delicate e sinuose nella lampada **Dizzy** in vetro di Murano soffiato disponibile nei colori bianco o fumè e realizzata con l'antica tradizione veneziana del vetro incamiciato, creando una parte trasparente e una parte opale. Disponibile bianca sfumata e fumè sfumata.

Precision and attention to the details in the spaces, delicate and sinuous shapes in the lamp **Dizzy** in Murano glass available in white or fumé color realized following the antique venetian tradition of the blown glass, creating a transparent part and an opal part. Available white shaded and fumé shaded.



ESCLUSIVO  
LIFE STYLE

EXCLUSIVE LIFESTYLE

Mini Dizzi P439X130  
Lampada da tavolo  
Table lamp  
Pag. 241

Dizzi P440X200  
Lampada da tavolo  
Table lamp  
Pag. 241



Onion Q233X125  
 Vaso in ceramica  
 White ceramic  
 Pag. 247

Vaso Onion nero e bianco con inserti platino. Onion vase white or black with platinum details. Pag. 247

I preziosi decori metallici come il platino si accompagnano a tutti i colori creando modernità, qualità e fashion design. The precious metallic decorations like platinum cobines with all colors creating modernity, quality and fashion design.

# BOOM DI SFUMATURE

BOOM OF SHADES

ATELIER



Hippo mini Q451/6X35  
 Scultura in ceramica  
 Ceramic sculpture  
 Pag. 243

Hippo Q439/6X60  
 Scultura in ceramica  
 Ceramic sculpture  
 Pag. 243

Hippo big Q440/6X180  
 Scultura in ceramica  
 Ceramic sculpture  
 Pag. 243



Hippo family in finitura golden black. Hippo family golden black finishing. Pag. 243





**Libreria 120 PALI120X795**  
 Libreria in metallo  
 Metal bookcase  
 Pag. 267



**Tob big Q107SRX42**  
 Vaso in ceramica rigato  
 Ridged ceramic vase  
 Pag. 246



**Tob big Q107X36**  
 Vaso in ceramica liscio  
 Smooth ceramic vase  
 Pag. 246



**Tob small Q106X30**  
 Vaso in ceramica liscio  
 Smooth ceramic vase  
 Pag. 246



**Chic small Q104X28**  
 Vaso in ceramica liscio  
 Smooth ceramic vase  
 Pag. 246



**Libreria 120** con vasi **Chic** e **Tob** bordeaux e nero lucidi.  
 Vaso **Chic** rigato in finitura bronzo metallica.  
 Library 120 with vases **Chic** and **Tob** bordeaux or black shiny.  
 Chic ridged metallic bronze finishing.

Collezione **Bamboo**. Bamboo collection. Pag. 242



**GLAMOUR NELLE FORME, NEI COLORI, EASY DA METTERE ASSIEME**  
 GLAMOUR IN THE SHAPES, IN THE COLORS, EASY TO COMBINE.

La nostra esperienza e qualità nelle finiture, come il bronzo sfumato, si abbina con effetto glamour ai colori senza tempo. Qui sopra vaso **Bamboo** in finitura bronzo e nero opaco. Tavolini **Bistrò** in collezione **Passepartout**. Our experience and quality in the finishing, like shaded bronze, combines with the glamour effect of the timeless colors. Above the **Bamboo** vase bronze or matt black finishing. **Bistrò** table collection **Passepartout**.

# OPERE D'ARTE PER OGGETTI MODERNI D'ARREDO

PIECE OF ART  
FOR MODERN FURNITURE

ATELIER

 **Cover C20AX18**  
Vaso in vetro  
Glass vase  
Pag. 268

 **Tulip Vase PATU30X155**  
Consolle in metallo  
Metal console  
Pag. 268

 **Hippo Wagon Q452/2X380**  
Scultura in ceramica  
Ceramic sculpture  
Pag. 243

 **Persia S129X400**  
Tappeto  
Rug  
Pag. 262



ADRIANI & ROSSI

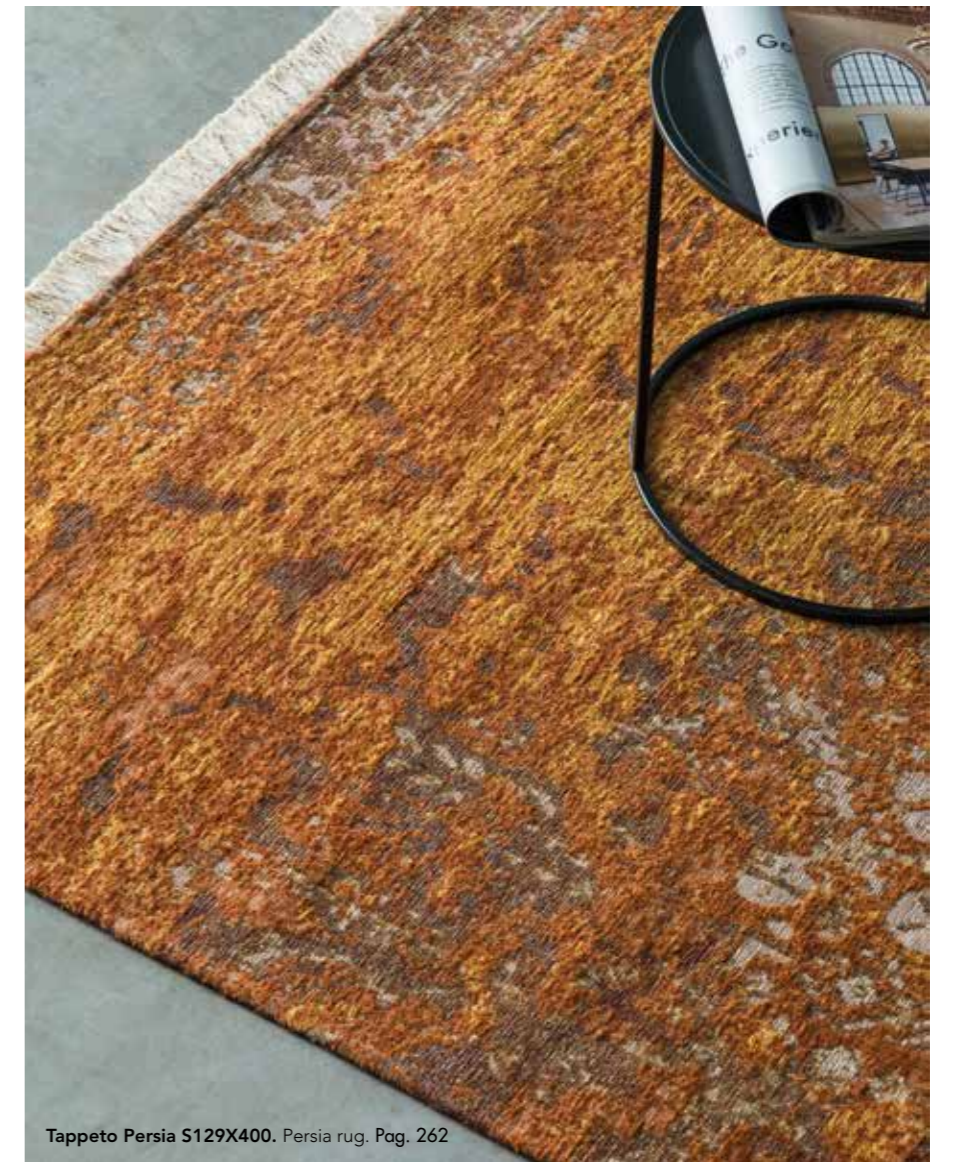

Tappeto Persia S129X400. Persia rug. Pag. 262



Il tappeto **Persia** ammicca nel design ad antichi decori. Realizzato con filati in ciniglia nei colori oro e corallo trova nelle frange e nell'effetto vintage spirito di modernità tutta da interpretare. Tappeto **Persia**, **Hippo Wagon** in oro 24 carati, portavaso vetro **Tulip** collezione **Passepartout**.

The **Persia** rug wink to antique decorations. Realized in chenille in the gold and red coral finds in the fringes and in the vintage effect a modernity spirit to be reinterpreted. **Persia** rug, **Hippo Wagon** 24 carat gold, **Tulip** with glass vase **Passepartout** collection.

Lampada fumè Babylon P367X120. Pag. 240  
Lamp Babylon fumé finishing.

# IL DESIGN ANNI '50

THE DESIGN OF THE '50

**Piantana Danish P462X298**

Floor lamp Danish bronze finishing. Pag. 238

**Tavolino multiuso Como collezione Passepartout PACO40X154**

Multipurpose table Square Passepartout collection. Pag. 266

**Quadro Murales F124MX150**

Murales painting. Pag. 257



**Ranocchi Queen e Prince in finitura Oxyd oro rosa e coroncina oro 24 carati.**  
Frog Queen and Prince oxyd finishing in pink gold and crown 24 carat gold.  
Pag. 246



**Queen Q495/8X85**

Scultura in ceramica.

Ceramic sculpture.

Pag. 246



**Prince Q496/8X85**

Scultura in ceramica.

Ceramic sculpture.

Pag. 246

**Lampada da tavolo Danish cromo e nero lucido P459X172**

Table lamp Danish chrome or shiny black. Pag. 238



**Tavolino multiuso Round PATR40X189**  
Multipurpose table Round. Pag. 266

Disegnare lo spazio, creare l'emozione della luce ricordo dei maestri del design scandinavo e degli anni '50. La lampada **Danish** con struttura in metallo in finitura acciaio o bronzo con cappello nero lucido.

Design the space, create the emotion of the light a memory of the masters of the Scandinavian design of the '50. The lamp **Danish** with metallic structure finishing chrome or bronze with shiny black lampshade.

# EFFETTI DI LUCE PER ATMOSFERE CALDE E COINVOLGENTI

PIECE OF ART  
FOR MODERN FURNITURE



Separè Quinta F158X300 Quinta separè booth. Pag. 261

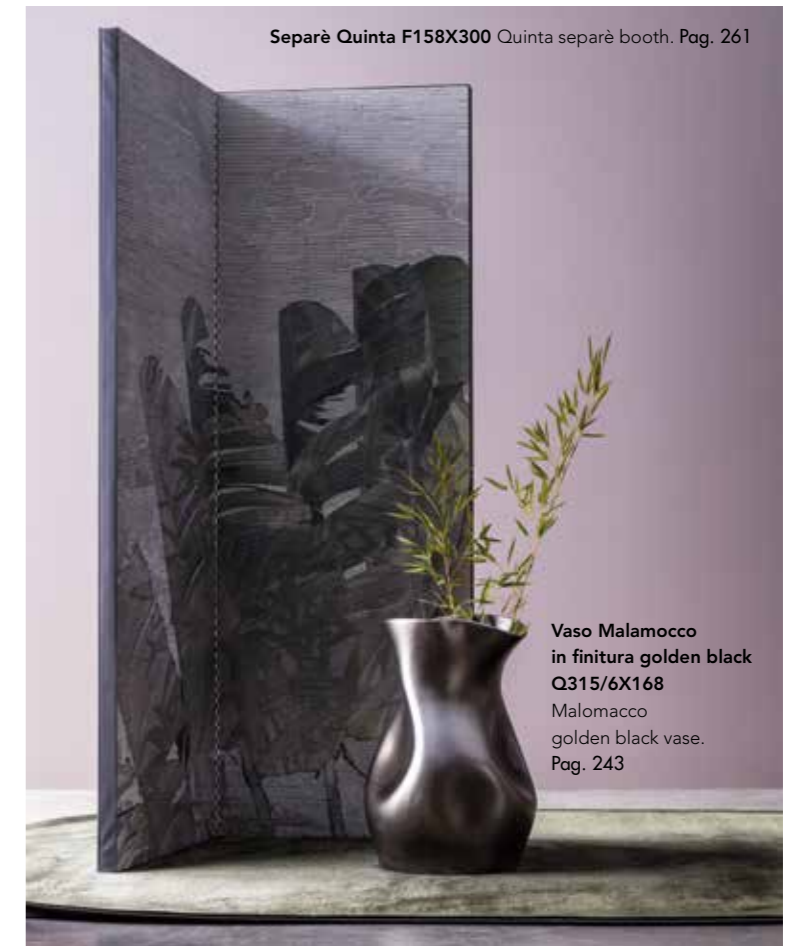

Vaso Malamocco  
in finitura golden black  
Q315/6X168  
Malamocco  
golden black vase.  
Pag. 243

## LA LAMPADA DADA DA TAVOLO O DA TERRA, HA LA POSSIBILITÀ DI POSIZIONARE LA LUCE A PIACERE

THE LAMP DADA,  
FLOOR LAMP O TABLE LAMP,  
HAS THE POSSIBILITY TO  
PLACE THE LIGHT AS YOU LIKE

 **Dada table P402X215**  
Lampada da tavolo  
Table lamp  
Pag. 238

 **Dada floor P403X264**  
Piantana  
Floor lamp  
Pag. 238

Lampada da tavolo Dada table P402X215 Pag. 238  
Table lamp Dada table.



Collezione lampade Torcello. Torcello lamps collection. Pag. 241

Torcello\_B P373X190  
Lampada a sospensione  
Hanging lamp  
Pag. 241

Serie di quadri **Oyster** e **Harmony** con profili metallici in ottone, acciaio. Stampa materica.  
Tavolini rotondi **Round** collezione **Passepartout**. Tappeto **Ginza** in ciniglia di cotone.  
Lampada **Torcello** in vetro di Murano con antiche lavorazioni dei maestri veneziani.  
Oyster and Harmony painting collection with metallic profile in brass, inox. Materic printing.  
Round table **Passepartout** collection, **Ginza** rug in chenille.  
Torcello lamp Murano glass realized following the ancient venetian techniques.

## GALLERIA D'ARTE

ART GALLERY

Collezione quadri Harmony e Oyster. Harmony and Oyster painting collection. Pag. 252 - 253



**View P441/2X410**  
Lampada a sospensione  
Hanging lamp  
Pag. 237



**View P442/2X410**  
Lampada a sospensione  
Hanging lamp  
Pag. 237



**Zoe Q126/5X125**  
Vaso in ceramica finitura metallica  
Glazed ceramic vase metallic finishing  
Pag. 244



**Four Season F137MX590**  
Set di 2 quadri materici  
Set of two materic printed  
Pag. 257



**Ginza S155X300**  
Tappeto  
Rug  
Pag. 262

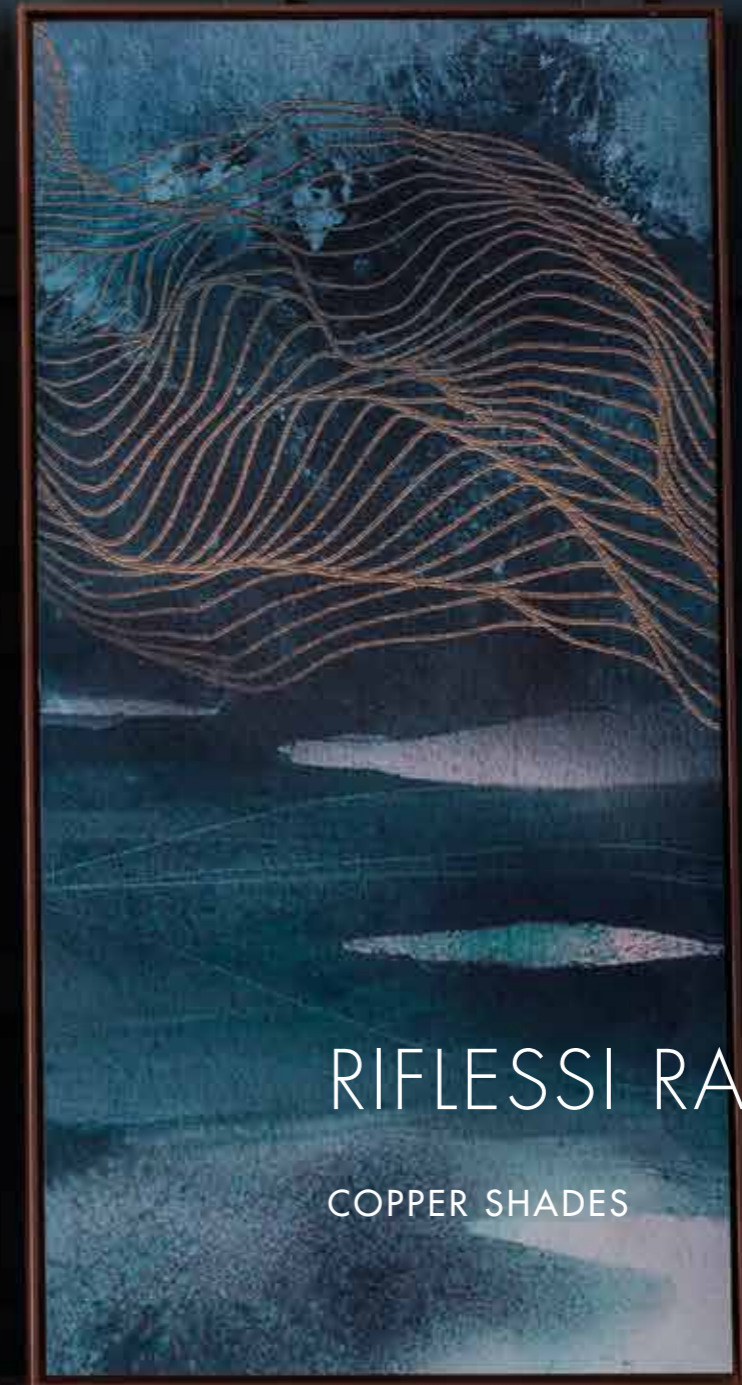

# RIFLESSI RAMATI

COPPER SHADES



### UN TREND CHE ACCAREZZA NUOVE AMBIENTAZIONI

A TREND THAT ENTERTAIN THE IDEA OF NEW SETTINGS

La lampada **Geo**, con grande verticalità e geometria in metallo finitura antracite racchiude la sfera tortora in vetro soffiato di Murano. A sinistra il quadro **Museum** in metallo verniciato Golden Black racchiude un bassorilievo materico. Sulla mensola **Line** della collezione Miss Mary, lampada **Camina** in finitura oro rosa e vaso in vetro blue **Elite** e vaso in vetro blue **Absolute**. The **Geo** lamp, with great verticality and geometry metallic structure varnished anthracite enclose the dove glass sphere in Murano blown glass. The metallic painting **Museum** golden black varnished enclose a materic low relief. On the shelf **Line** collection Miss Mary the lamp **Camina** pink gold finishing and the glass blue vase **Elite** and the blue glass **Absolute**.

**Museum F138BX190**  
Quadro artistico in metallo  
Artistic metallic painting  
Pag. 258

**Geo P425X340**  
Lampada a sospensione  
Hanging lamp  
Pag. 237

**Camina P449X190**  
Lampada da tavolo  
Table lamp  
Pag. 241

**Elite C202AX30**  
Vaso in vetro  
Glass vase  
Pag. 248

**Absolute C200BX44**  
Vaso in vetro  
Glass vase  
Pag. 248

## FASCINO CREATIVO

CREATIVE CHARM

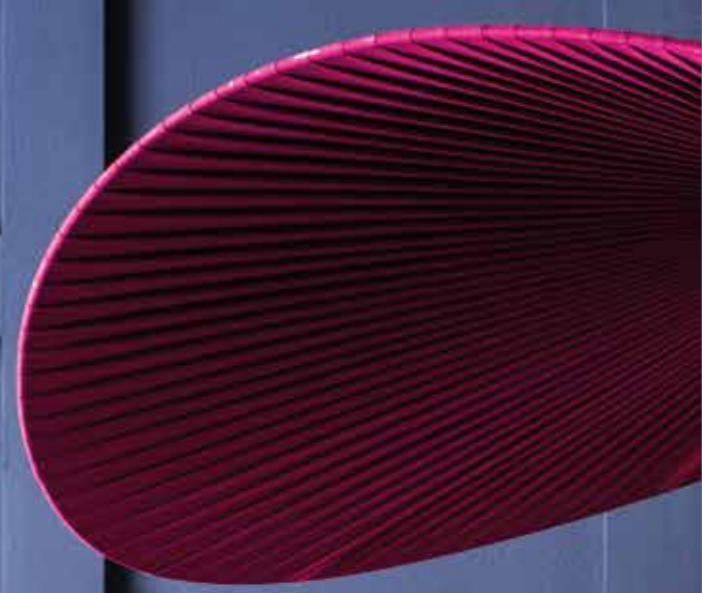

La lampada **Vogue** in plissé bordeaux con sfera in vetro soffiato tortora di Murano. Sculture **Buongiorno** e **Buonasera** in ceramica scolpita nelle finiture ramate e Golden black. A sinistra serie di ceramiche smaltate nel colore Bordeaux della collezione **Passade** e **Hippo mini** in colore bordeaux. The **Vogue** lamp pleated woven Bordeaux color with dove sphere in Murano blown glass. **Buongiorno** and **Buonasera** sculpture in engraved ceramic in the copper and golden black finishing. On the left lacquered ceramic in Bordeaux color from the collection **Passade** and **Hippo mini** bordeaux color.

 **Vogue Plissé small P445X320**  
Lampada a sospensione  
Hanging lamp  
Pag. 236

 **Buongiorno Q454/5X80**  
Scultura in ceramica opaca  
Matt ceramic sculpture  
Pag. 245

 **Buonasera Q455/5X80**  
Scultura in ceramica opaca  
Matt ceramic sculpture  
Pag. 245



## MONDO DESIGN

## DESIGN WORLD

Fascino e sexy emotion. Coordinati nelle geometrie e nei colori il comodino **Como** della collezione Passepartout in metallo verniciato. Lampada da tavolo **Planeta** laccata nero opaca con specchio orientabile. Il separé pieghevole **Quinta** con stampa pied di poule, il pouff in gres porcellanato **Nappe** in finitura antracite. Charm and sexy emotion. Table lamp **Planeta** lacquered matt black with adjustable mirror. Coordinated in the geometry and in the colors, the metallic varnished bed side table **Como** Collection Passepartout and the table lamp with adjustable mirror. The separé booth **Quinta** with pied de poule printing, the stoneware **Nappe** pouf anthracite color.



Materiali e colori che trasmettono un senso di rilassante eleganza. Lo scrittoio **Desk** della collezione Passepartout si posiziona ovunque. La lampada da tavolo **Danish** in finitura nera e cromo con paralume nero lucido. Comodino **Round** e lampada a led angolare **Ellen** disegna lo spazio illuminando con vera geometria. Tappeto Land grigio. Specchiere **Brame** con specchio fumè. Pouff **Nappe** in gres porcellanato antracite opaco. The materials and the colors spread a sense of relaxing beauty. The **Desk** from Passepartout collection fits everywhere. Table lamp **Danish** black finishing with chromed structure. Bed side table **Round** round shape, Led lamp **Ellen** design the space. Grey rug Land. Mirrors **Brame**. Pouff **Nappe** stoneware in anthracite color.

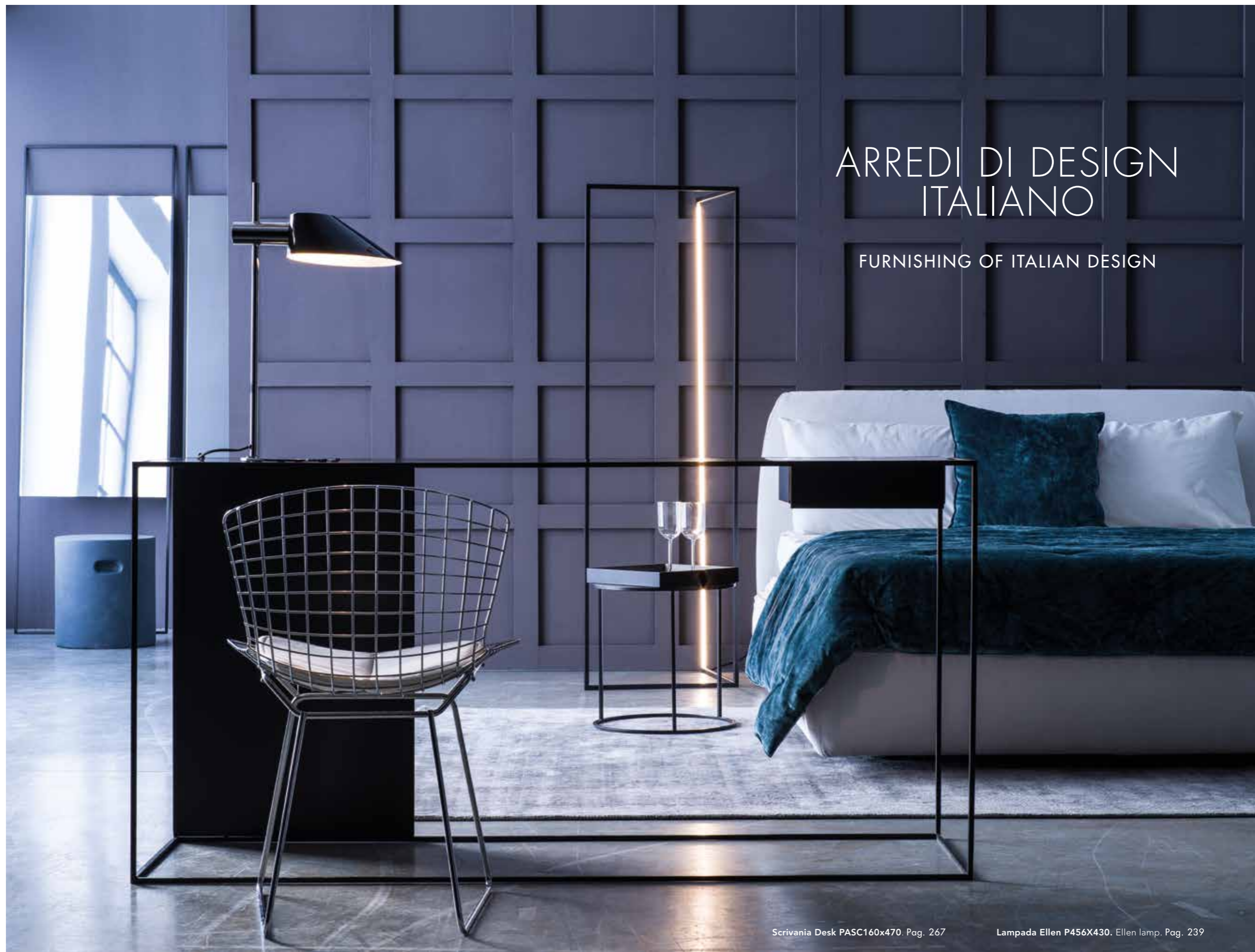

# ARREDI DI DESIGN ITALIANO

FURNISHING OF ITALIAN DESIGN

Scrivania Desk PASC160x470. Pag. 267

Lampada Ellen P456X430. Ellen lamp. Pag. 239

## CORNICE LUMINOSA LIGHTING FRAME

Una simbiosi di progetto che passa dalle specchiere in vetro fumé con struttura in metallo 1x1 cm alle lampade applique **Window** in finitura oro rosa illuminate a luce Led nel sottile profile di 1 cm.

A symbiosis in the project that passes through the mirror in fume glass with metallic structure 1x1 and through the wall lamps **Window**.



Applique Window P458X390. Wall Window lamp. Pag. 239

## OLTRE LO SPECCHIO

BEYOND THE MIRROR



Fioriera Ambrella D184X200. Flowerpot. Pag. 267

Specchiera Brame PASP60X286. Mirror Brame. Pag. 269



# LA JOIE DE VIVRE

**AFFINITÀ ELETTIVE NEL SIMBOLO HIPPO**  
SPECIAL AFFINITY IN THE SYMBOL OF THE HIPPO

Hippo Collection. Pag. 243



Vaso vetro  
Guest C203X39.  
Guest glass vase.  
Pag 249



Lampada da tavolo Caminia P449X190. Caminia table lamp. Pag 241

**ELEMENTI PROGETTATI CON  
GRANDE ATTENZIONE AL  
DETTAGLIO REALIZZATI IN  
ITALIA, PER UNA VOCAZIONE  
INTERNAZIONALE**

ELEMENTS DESIGN WITH  
ATTENTION TO THE DETAIL  
MADE IN ITALY, FOR AN  
INTERNATIONAL CALLING



Lampada Eclipse P438/2X150. Eclipse lamp. Pag. 237



PROGETTO  
D'INSIEME

COLLECTIVE PROJECT

# MONDI DIFFERENTI PER UNO STILE SU MISURA

DIFFERENT WORLDS  
FOR A  
CUSTOMIZED  
STYLE



Scultura Cherry Q243X120. Cherry sculpture. Pag 244

**CREIAMO OGGETTI CON  
LA PASSIONE PER LA  
SCENOGRAFIA, PER LA  
SCULTURA, PER L'ARTE,  
DIVENTATI MUST COME  
L'IPPOPOTAMO, LA  
SCULTURA CILIEGIA  
CHERRY E IL PRINCIPE  
RANOCCHIO.**

WE CREATE OBJECTS WITH  
THE PASSION FOR THE  
SCENOGRAPHY, FOR THE  
SCULPTURE, FOR THE ART,  
THEY BECAME A MUST HAVE  
LIKE THE HIPPO, THE CHERRY,  
THE FROGGY PRICE.



Teca collection. Pag 251



Lampada da tavolo Mini Dizzi P439X130. Mini Dizzi table lamp. Pag 241



IMMAGINI  
D'AUTORE

AUTHOR'S IMAGES



**Cigar Q353/5X164**  
Vaso in ceramica metallico  
Ceramic vase metallic finishing  
Pag. 244



**Quinta F158X300**  
Separè stampato  
Separé booth  
Pag. 261



**Como PACO40X154**  
Comodino  
Bedside tables  
Pag. 266



Serie collezione Venissa. Pag 242



Piantana Plissy in tessuto plissettato P455X530.  
Plissy floor lamp pleated. Pag 238

Finiture e installazioni decor che arricchiscono gli ambienti. Il separé Quinta con possibilità di decoro a piacimento, divide lo spazio e allo stesso tempo crea prospettiva e scenografia d'interno.

Finishing and installation "decor" enrich the spaces. The Quinta separé with the possibility to decorate upon your taste, divide the space and at the same time it creates prospective and interior scenography.

TONO  
SU TONO

TONE ON TONE

ATELIER



TAPPETO MERAV  
MERAV RUG

Protagonista assoluto il colore, prezioso contenuto per arricchire la qualità all'interior e per esaltare il vero colore. Il tappeto **Merav** in tessuto di ciniglia, trova la leggerezza dei delicati colori pastello e delle geometrie floreali. Absolute protagonist the color, precious content to enrich the quality to the interior and to exalt the real color. The chenille rug **Merav** finds the lightness of delicate pastels colors and of the flowers geometry.





Sculptura Buongiorno e Buonasera in ceramica colorata, blue e fuxia Q454/1X70.  
Sculptures Buongiorno and Buonasera colored ceramic, blue and fuchsia.  
Pag 245



Particolare lampada Plissy  
Plissy lamp detail

**LA DELICATEZZA DEI COLORI PASTELLO, LE TONALITÀ DEI GRIGI PERLA SI TRASFORMA IN VIVACE COLORE NEGLI ELEMENTI SCULTOREI NELLA MAGIA DEL COLORE BLUETTE E FUXIA.**

THE SOFTNESS OF THE PASTEL COLORS, THE SHADE OF THE PEARL GREY COLOR TURNS INTO INTENSE COLOR IN THE SCULPTURE ELEMENTS IN THE MAGIC OF THE LIGHT BLUE AND FUCHSIA COLOR.

SEMPLICEMENTE  
CREATIVI  
SEMPLICEMENTE  
BELLI

SIMPLY CREATIVES  
SIMPLY BEAUTY

ATELIER



Piantana Plissy in tessuto plissettato P455X530.  
Plissy floor lamp pleated. Pag 238







Elite collection. Pag. 248

I COLORI DELLA TRADIZIONE  
ATELIER OF RESEARCH

I colori della tradizione dei vetri veneziani trasforma i vasi **Absolute** ed **Elite** vera modernità, facile da accostare ai mood dell'interior. The colors of the traditional venetian glass transform the vases **Absolute** and **Elite** in perfect modernity, easy to match with the interior design mood.

 **Elite C202AX30**  
Vaso in vetro blu  
Blue glass vase  
Pag. 248

 **Elite C202BX40**  
Vaso in vetro fumè  
Smoked grey glass vase  
Pag. 248

# LE MERAVIGLIE DEL COLORE

THE SPLENDOR OF THE COLOR

## ATELIER

 **Absolute C200AX40**  
Vaso in vetro fumè  
Smoked grey glass vase  
Pag. 248

 **Absolute C200BX44**  
Vaso in vetro blu  
Blue glass vase  
Pag. 248

 **Absolute C200CX48**  
Vaso in vetro ametista  
Amethyst glass vase  
Pag. 248



Absolute collection. Pag. 248



**Tappeto Boss grigio.**  
Boss grey rug.  
Pag 262



**Orizzonte collection.** Pag 242

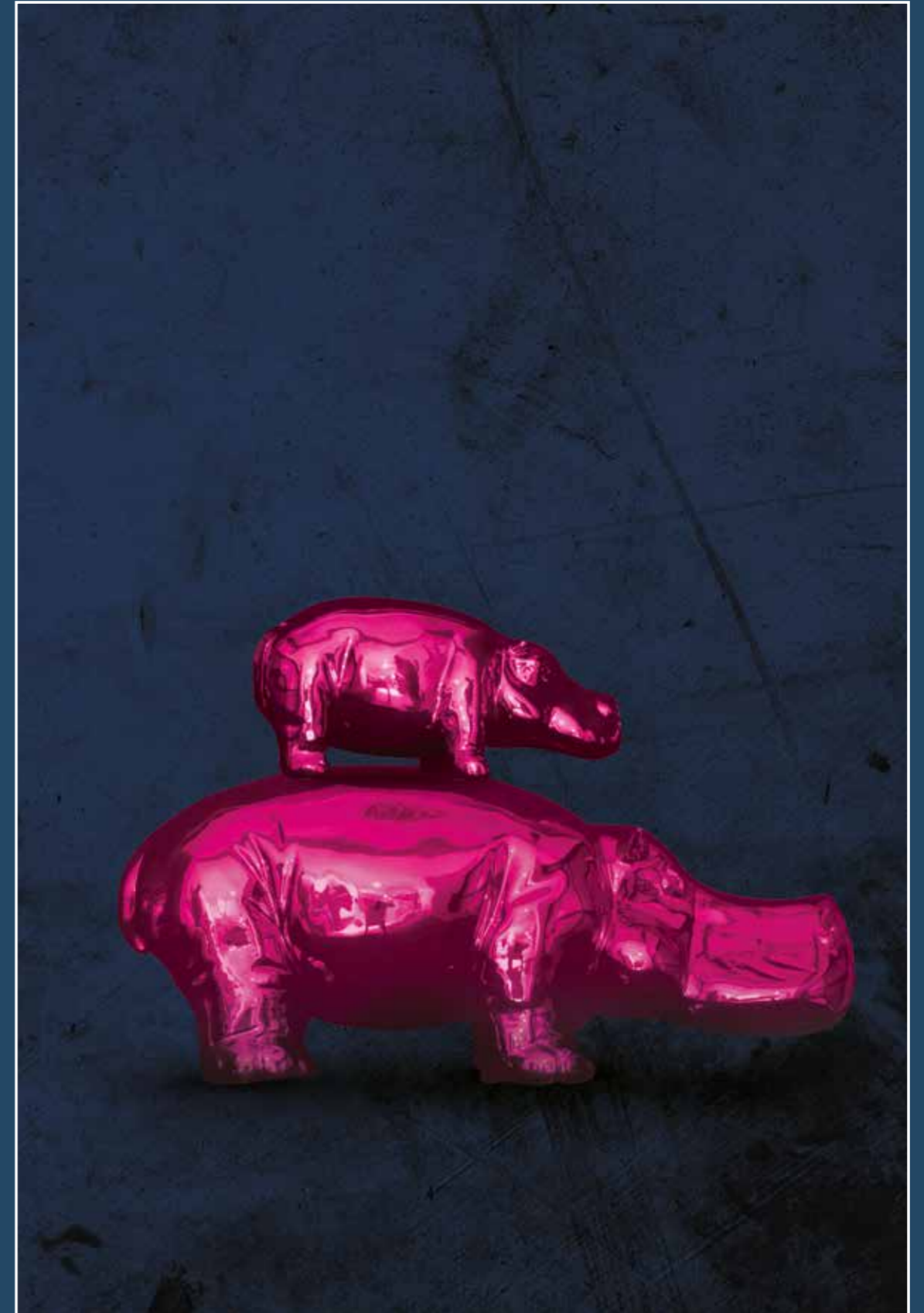

**Hippo fuxia Q439/MX60**  
**Hippo big fuxia Q440/MX240**  
Pag 243



Vaso in ceramica Onion Q233X125.  
Onion ceramic vase. Pag 247

# ATELIER DI COLLEZIONE

ATELIER COLLECTION



Rana Queen Q495/3X38.  
Prince Q496/3X55.  
Pag 246



Scultura Hippo corallo Q439X50.  
Hippo sculpture coral finishing.  
Pag 243

## CORALLO CORAL

Protagonista assoluto **Hippo** in versione ceramica smaltata corallo un must di ADRIANI & ROSSI e che rievoca i colori degli anni '60. Modernità nella scultura facile da abbinare ai colori dell'interior. Starring role the **Hippo** version lacquered ceramic coral a must have of ADRIANI & ROSSI that reminds the colors of the Sixty. Modernity in the sculpture as easy to combine with the interior colors.

## TIMELESS PLISSÉ

Lampada **Vogue** plissé nella delicata colorazione grigio perla con sfera bianco in vetro soffiato di Murano. Piantanta **Plissy** a 3 lampade con regolazione. Tavolo coffe table **Square** della collezione Passepartout. Vasi **Venissa** in ceramica smaltata bianca opaca incisi con decori tramati. Tappeto **Klee** in ciniglia. Vogue lamp pleated woven in the delicate pearl grey color with white sphere in Murano blown glass. Floor lamp **Plissy** 3 bulbs with dimmer. Coffe Table **Square** Passepartout collection. **Venissa** carved ceramic vases matt white color with decoration. **Klee** chenille rug.

**Vogue plissé big P446X540**  
Lampada a sospensione.  
Hanging lamp.  
Pag. 236

**Plissy P455X530**  
Piantana in tessuto plissettato.  
Floor lamp pleated woven.  
Pag. 238

**Square PATS140X416**  
Tavolino Square.  
Square coffee table.  
Pag. 266

**Klee S166X960**  
Tappeto tessuto in viscosa.  
Viscose rug.  
Pag. 263

# BLU, CLASSICO EVERGREEN

BLUE, CLASSIC EVERGREEN



Hippo madreperla turchese. Hippo mother of pearl turquoise. Pag 243

I VETRI SOFFIATI BLU COBALTO **ABSOLUTE** ED **ELITE** SI CONTRAPPONGONO ALLE TRASPARENZE DEI VETRI **POLINE** CON DECORI GEOMETRICI INCISI. LE LAMPADIE **FLOU** POSSONO ESSERE A RICHIESTA BLU INCAMICIATO IN VETRO SOFFIATO DI MURANO (ANTICA TECNICA VENEZIANA). TAVOLO COFFEE TABLE **SQUARE** E LIBRERIA DELLA COLLEZIONE **PASSEPARTOUT**. TAPPETO **MERAV** IN CINIGLIA CON DECORO FLOREALE. THE BLOWN GLASS COBALT BLUE **ABSOLUTE** OR **ELITE** CONTRAST WITH THE CLEARNESS OF THE GLASS **POLINE** WITH GEOMETRIC DECORATION. THE LAMPS **FLOU** CAN BE UPON REQUEST BLUE MURANO BLOWN GLASS (ANCIENT VENETIAN TECHNIQUE) COFFEE TABLE **SQUARE** AND LIBRARY FROM **PASSEPARTOUT** COLLECTION **MERAV** CHENILLE RUG WITH FLORAL DECORATION.



SFUMATURE  
FUMÉ

FUMÉ SHADES





Hippo madreperla turchese. Hippo mother of pearl torquoise, Pag. 243

NEL BLU DIPINTO DI BLU  
IN THE BLUE PAINTED BLUE

Combinazioni di colori, per progetti **Total Look**, sfumature leggere per intriganti progetti. A destra le lampade **Flou** in vetro di Murano fumé incamiciato antica tecnica del vetro veneziano creano un vero effetto flou. I vasi **Pongo** in vetro soffiato fumé di Murano, sono nello stesso colore per creare vero progetto **total look**. Tavolino coffee table **Round** della serie **Passepartout**. Colors combinations, for **Total Look** projects, light shades for interesting projects. **Flou** lamps in Murano glass fume blown glass according the ancient venetian technique creates a real flou effect. The vases **Pongo** in Murano blown glass, in the same color to create a real **Total Look** project. Table Coffe Table **Round** from the **Passepartout** Collection.

 **Pongo C178X100**  
Vaso in vetro  
Glass vase  
Pag. 248

 **Pongo C179X150**  
Vaso in vetro  
Glass vase  
Pag. 248

 **Flou P433X290**  
Lampada a sospensione  
Hanging lamp  
Pag. 236

 **Flou P434X290**  
Lampada a sospensione  
Hanging lamp  
Pag. 236

 **Round PATR120X364**  
Tavolini rotondi  
Coffee tables rounder  
Pag. 266

MR BLUE



Mr. Blue collection. Pag 245





Tappeto Ormus S159X660. Ormus rug. Pag 262



Mr. Blue collection. Pag 245

Una leggera sfumatura ossidata ruggine, crea in **Mr. Blue** la ricercatezza della finitura, antica e moderna interpretazione. Tappeto **Ormus** in filato di silk bamboo. Librerie della collezione **Passepartout**. Vasi **Bouble** in vetro soffiato di Murano con struttura inox. A light shade oxidize rust, creates in **Mr Blue** the attention to the finishing, ancient and modern interpretation of the shapes. **Ormus** rug silk bamboo yarn. Library from **Passepartout** Collection. **Bouble** vases in Murano blown glass inox structure.

# GIALLO DESIGN

## YELLOW DESIGN

Le ceramiche della collezione **Passade** smaltate giallo o nero opaco, diventano tema unico con i quadri scolpiti verniciati lucidi **Miss Italia**. Tappeto **Merav** in ciniglia con decoro floreale. Coffee table **Round** e librerie della collezione **Passepartout**. The ceramic from the **Passade** collection glazed yellow or matt black, becomes unique subject with the carved lacquered painting **Miss Italia**. Chenille Rug **Merav** with floreal decoration. Coffe table **Round** and library from the **Passepartout** collection.

 Libreria 80 PALI80X690  
Libreria  
Bookcase  
Pag. 267

 Libreria 120 PALI120X795  
Libreria  
Bookcase  
Pag. 267

 Round PATR80X239  
Tavolini rotondi  
Coffee tables rounder  
Pag. 266

 Passade collection  
Pag. 242

 Miss Italia collection  
Pag. 256



**COLORI DI TENDENZA E CLASSICI RIVISITATI**  
TREND COLORS AND REVISITED CLASSIC

Le ceramiche di **Passade** Collection smaltate giallo o nero opaco, diventano tema unico con i quadri scolpiti verniciati lucidi **Miss Italia. Libreria 120** e coffee table **Round Passepartout**. The ceramic from the **Passade** collection glazed yellow or matt black, becomes unique subject with the carved lacquered painting **Miss Italia. Library 120** and coffee table **Round Passepartout**.



IT'S TIME  
FOR DESIGN





# ATELIER COLLECTION

## ATELIER





Come uno show che trasforma il gioco e il piacere di poter abbinare. Lampada **Vogue** in metallo verniciato oro con sfera in vetro soffiato tortora di Murano. Vaso scultura **Onda** in ceramica con finitura nero opaco. Vasi **Bamboo** in ceramica verniciata nero opaco e bronzo sfumato. Like a show that transform the game and the pleasure to match. **Vogue** metallic lamp varnished gold with Murano blown glass sphere. Sculpture ceramic vase **Onda** matt black finishing. **Bamboo** ceramic vases in matt black or shaded bronze finishing.

 **Vogue small P381/2X300**  
Lampada a sospensione  
Hanging lamp  
Pag. 236

 **Bamboo Q491/3X50**  
Vaso in ceramica  
Ceramic vase  
Pag. 242

 **Bamboo Q491/5X60**  
Vaso in ceramica  
Ceramic vase  
Pag. 242

 **Bamboo Q492/5X82**  
Vaso in ceramica  
Ceramic vase  
Pag. 242

 **Onda Q193/3X90**  
Vaso in ceramica  
Ceramic vase  
Pag. 247

# ATMOSFERA UNICA

UNIQUE ATMOSPHERE



Hippo mini Q451/6X35  
Hippo Big Q440/6X180  
Pag. 243

Mixare colori e metalli per creare un'atmosfera unica, un po' magica, senza tempo. Collezione di vasi in ceramica con finiture metalliche golden black. Tappeto **Rainbow**, separè **Quinta** e quadro **Murales**.

Mixing the colors and the metals to create unique atmosphere, a little bit magic, timeless. Collection of ceramic vases with metallic golden black finishing. **Rainbow** rug, **Quinta** separè booth and **Murales** painting.



Zoe Q126/6X125. Pag. 244



**Cherry wall double Q282X210**  
Ciliegie a muro in ceramica  
Ceramic cherries for wall  
Pag. 261



**Cherry wall Q256X110**  
Ciliegie a muro in ceramica  
Ceramic cherries for wall  
Pag. 261



**Tulip 80 PATU80X168**  
Consolle in metallo  
Metal console  
Pag. 268



**Nappe Q497X90**  
Pouf in gres porcellanato  
Pouf in porcelain stoneware  
Pag. 272



Venissa collection Q483/3X50  
Venissa collection Q484/3X60  
Pag. 242

## ARMONIA DI FORME ARMONY OF SHAPES

Le ciliegie a muro **Cherry**, un vero must da oltre 20 anni, crea sempre un'emozionante ricerca scultorea. Elemento **Passpartout** e pouf **Nappe** in gres porcellanato nel colore antracite opaco. Qui sopra vasi collezione **Venissa** in ceramica bianca opaca incisi a sbalzo. Wall **Cherry**, a must have since 20 years, it creates always an emotion sculpture research. **Passpartout** element and pouf **Nappe** stoneware matt anthracite color. Above collection **Venissa** white ceramic with embossed decoration.

# IMMAGINI D'AUTORE

AUTHOR'S IMAGES



Tappeto Land S139X390. Land rug Pag. 263

Quadro Harmony F128M/BAX220. Harmony painting. Pag. 252



Rigore progettuale per ambienti dedicati al contract. Confortevole, ora un classico d'eleganza. Comodini **Como** della collezione **Passepartout**. Porta abiti **Gruccia** della collezione **Passepartout**. Tappeto **Land**. Lampada **Caminia** da comodino in vetro opale rosa. Quadro **Harmony** con inserto in ottone e cornice in golden black.

Project rigour to area dedicated to the contract comfortable, a classic of elegance. Bedside table **Como** from the **Passepartout** collection. Coat hanger **Gruccia** from the **Passepartout** collection. Rug **Land**. Table lamp **Caminia** opal pink glass. **Harmony** painting with brass insert and golden black frame.



**Caminia P450X180**  
Lampada da tavolo  
Table lamp  
Pag. 241



**Como PACO40X154**  
Comodino  
Bedside tables  
Pag. 266



**Land Grey S139X390**  
Tappeto  
Rug  
Pag. 263

**HIGH PERFORMANCE PER  
UN'ESTETICA RAFFINATA,  
TRA EFFETTI MATERICI E MOTIVI  
DECORATIVI.**

HIGH PERFORMANCE FOR A  
SOPHISTICATED AESTHETIC,  
BETWEEN MATERIC EFFECT  
AND DECORATIVE MOTIF.

Tappeto **Ginza** in ciniglia nella  
colorazione turchese con decoro  
geometrico ad effetto vintage e pouf  
**Nappe**. Ginza chenille rug light blue  
color with geometric pattern vintage  
effect and Nappe pouff.

Tappeto Ginza S155X300. Pag. 262



Quadri Murales. Pag. 257

**GEOMETRIA E FANTASIA**  
GEOMETRY AND FANTASY

La geometria e il rigore di **Passepartout** lo ritroviamo nella cornice dei quadri **Murales**. Tutti i decori delle carte da parati **ADRIANI & ROSSI** possono essere riprodotti nei quadri materici con effetto cementizio. Qui sopra tappeto **Boss** nel colore grigio con decoro geometrico a rilievo quadratino, pouff **Nappe** in gres porcellanato antracite opaco Lampada da terra **Danish** in finitura ottone e paralume nero lucido. Tavolino di servizio **Como** della serie **Passepartout**. The geometry and the precision of the **Passepartout** collection, we find them in the frame of the painting **Murales**. All the graphics of our wallpaper collection **ADRIANI & ROSSI** can be reproduced in the materic painting concrete effect. On the floor the rug **Boss** grey color with geometric decoration on relief, pouff **Nappe** stoneware matt anthracite, floor lamp **Danish** brass finishing and lampshade shiny black, **Como** bedside table **Passepartout** collection.



# IL NOSTRO STILE

OUR STYLE



**UN SEGNO LUDICO  
E LEGGERO,  
UN TOTAL LOOK  
A COLORI**

A SHINY  
AND LIGHT SIGN,  
A TOTAL LOOK  
OF COLORS



Lampada Vogue small P381/CX300. Vogue small lamp. Pag. 236

Vasi Venissa bianchi. Venissa white vases. Pag. 242



Console Step vase PAST120X490. Pag. 268

Vaso in ceramica Nice Q111/3X72. Nice ceramic vase. Pag. 268

## ATELIER - LA CURA DEL DETTAGLIO THE ATTENTION TO THE DETAIL

Le consolle della collezione **Passepartout** possono essere usate in vari modi e dedicate per vari ambienti: nell'entrata, nella zona giorno, a dividere lo spazio di un divano o nella zona bagno o nella camera da letto come mobile porta oggetti o vestiario. Utile nell'hotellerie e negli spazi **contract**. The console from **Passepartout** collection can be used in different ways and dedicated for different areas: entrance, living room, to divide the space of a sofa or in the bathroom or in the bedroom as accessory furniture or for the closet. Useful for the hotellerie and in the contract.



Tappeto Ormus acquamarina S159X660. Aquamarine Ormus rug. Pag. 264



Hippo Wagon Q452/2X380. Pag. 243

Tulip Vase PATV30X155 . Pag. 268  
Vaso in vetro Cover C20AX18. Pag. 268  
Cover glass vase.

Tulip PATU30X145. Pag. 268

UN'IMMAGINE, MILLE PAROLE  
AN IMAGE, THOUSAND WORDS

Il trespolo portavaso **Tulip** vase disegna la sospensione e rafforza la trasparenza del vetro.  
Elemento museale come **Hippo Wagon**. Perch Tulip design the suspension and strength the glass transparence.  
Museum element like **Hippo Wagon**.

GEOMETRIA E FORME ORGANICHE  
CREANO SPAZIO ALLA CREATIVITÀ.  
COLLEZIONE DI QUADRI MATERICI OYSTER  
CON INSERTO METALLO,  
TAPPETO LINE GRIGIO PERLA.

GEOMETRY AND ORGANIC SHAPES DESIGNS  
THE SPACE AND THE CREATIVITY.MATERIC  
PAINTING COLLECTION OYSTER WITH  
METALLIC INSERT, LINE PEARL GREY RUG.

ATELIER





## OCEANO

**LA SENSAZIONE DI IMMERGERE LO SGUARDO  
NELL'OCEANO, MATERICO, IN FINITURA CEMENTIZIA,  
CON COLORAZIONE BLU COBALTO E CON CORNICE  
LACCATA IN FINITURE METALLICHE**

THE SENSATION TO LOSE THE SIGN IN THE OCEAN, MATERIC  
CONCRETE EFFECT COBALT BLUE COLOR WITH LACQUERED  
FRAME METALLIC FINISHING

Quadri Oceano collection. Oceano painting collection. Pag. 256

# LUCENTE MODERNITÀ

SHINING MODERNITY

Lampada a sospensione Rosy gold P376X159  
Rosy gold hanging lamp Pag. 239

ADRIANI & ROSSI



Camina P449X190  
Lampada in oro rosa antico  
Lamp antique pink gold.  
Pag. 241

La cura del dettaglio e la qualità dei materiali è la vera essenza del lusso, la lampada **Rosy Gold** in vetro di Murano soffiato in finitura tortora con particolari in metallo cromati oro. Le uova **Fabergè** in ceramica smaltata oro 24 carati o vero platino. Attention to detail and the quality of the materials is the real essence of the luxury, the lamp **Rosy Gold** in Murano glass vase dove finishing with metallic chromed gold details. **Fabergè** eggs in glazed 24 carat gold ceramic or real platinum.



Fabergè collection. Pag. 244



# LINEE ESSENZIALI

ESSENTIAL LINES





VASI LORD  
LORD VASES

Meraviglia del vetro di Murano fumè. Dove la tecnica trova le geometrie della forma. I vasi **Lord** sono in vetro fumè, delicato colore ricco nelle forme. Wonder of the Murano fumé glass. The technique finds the geometry of the shapes. The **Lord** vases fume color, delicate rich color in the shapes.





Mito cross C183AX200  
Vaso in vetro  
Glass vase  
Pag. 250



Mito cross C183BX220  
Vaso in vetro  
Glass vase  
Pag. 250



Four season F137HX390  
Quadri materici  
Materic paintings  
Pag. 257



Habibi Q404/6X102  
Scultura in ceramica  
Ceramic sculpture  
Pag. 245



Amal Q405/6X102  
Scultura in ceramica  
Ceramic sculpture  
Pag. 245



Volare sound big P384/SX360  
Lampada a sospensione  
Hanging lamp  
Pag. 236



## NEW WAVE ATELIER

**PROGETTI CHE AMMORBIDISCONO LE LINEE E DIVENTANO  
COINVOLGENTI PER L'INTERIOR DESIGN. ATELIER UNA COLLEZIONE DI  
LAMPADE, QUADRI, VASI E TAPPETI, COORDINATA E UNICA**  
PROJECTS THAT SOFTEN THE LINES AND BECOME FASCINATING FOR THE  
INTERIOR DESIGN. ATELIER A COLLECTION OF LAMPS, PAINTINGS, VASES  
AND RUGS, COORDINATED AND UNIQUE

MALAMOCCO  
FLUTTUANTI  
FORME

MALAMOCCO  
FLOATING FORMS





# FUSIONE DI MODERNITÀ

## MODERNITY FUSION



**Torcello A P372X190**  
Lampada a sospensione  
Hanging lamp.  
Pag. 241



**Torcello B P373X190**  
Lampada a sospensione  
Hanging lamp.  
Pag. 241



**Torcello C P374X190**  
Lampada a sospensione  
Hanging lamp.  
Pag. 241



**Torcello D P375X190**  
Lampada a sospensione  
Hanging lamp.  
Pag. 241



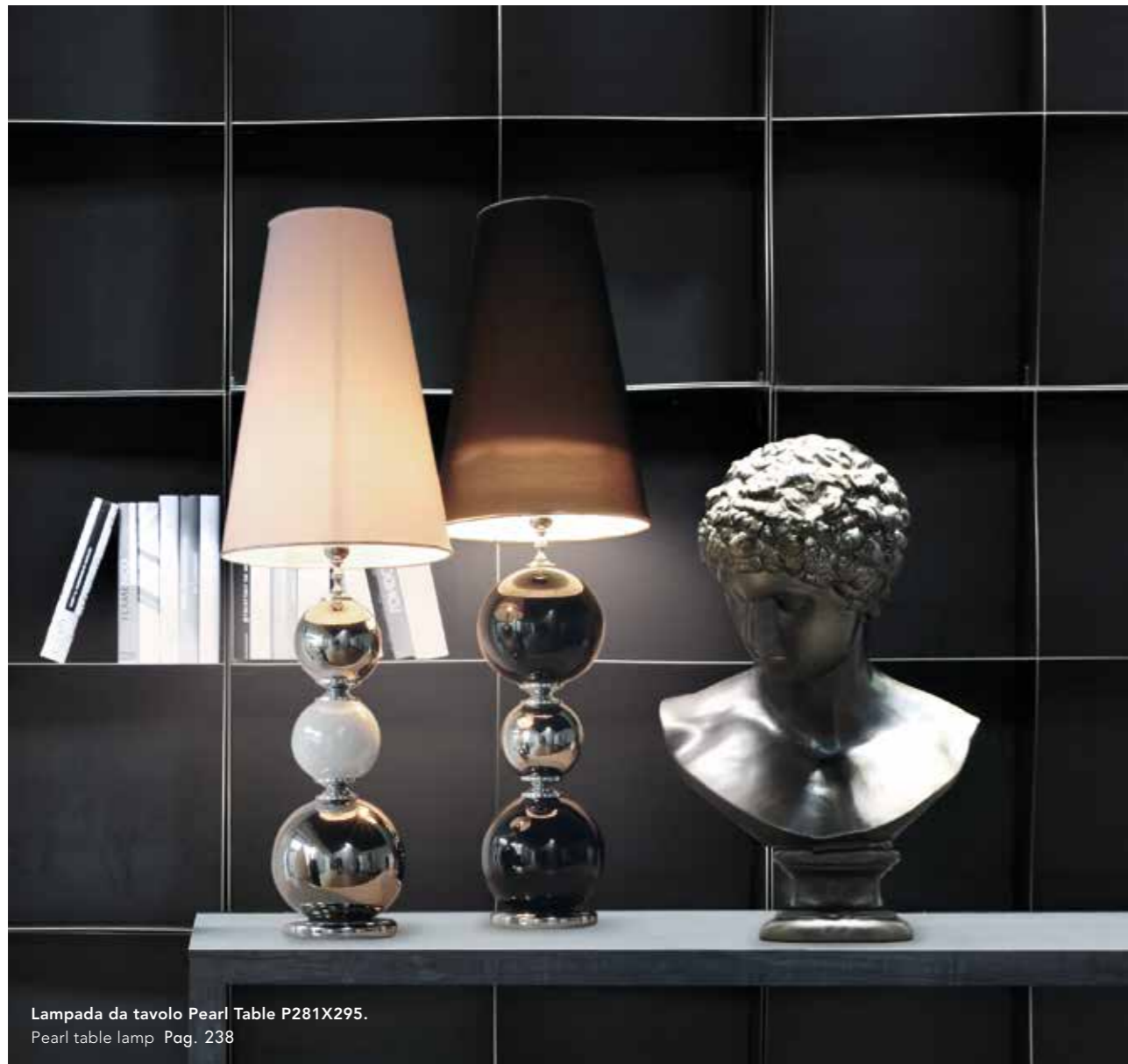

Lampada da tavolo Pearl Table P281X295.  
Pearl table lamp Pag. 238

LUXURY

Lo stile di rinnovata eleganza, la lampada **Pearl** con struttura in ceramica in finitura platino e bianco o nero lucido con inserti cromati e paralume in tessuto bianco o nero con profilo cromato. The style of new elegance, the lamp **Pearl** with ceramic structure platinum and glazed black and white with chromed details , textile lampshade white or black color with chromed profile.

PEARL



Lampada Pearl Floor P282X530.  
Pearl table lamp Pag. 238



Fabergè collection. Pag. 244



Cherry floor double Q244/6X190. Pag. 244

BEST SELLER

Sull'onda della ricerca, da 30 anni produciamo oggetti scultorei e creativi dedicati all'interior e diventati must in tutto il mondo. **Mela** e la **Pera** giganti in finitura Golden Black, **Cherry** in ceramica in finitura Golden Black e serie di uova **Fabergè** in ceramica con finiture metalliche. Creazioni di grandi forme inventate da ADRIANI & ROSSI The research wave, since 30 years we produce sculpture objects and innovation dedicated to the interior which become a must have in the hole world. **Mela** and **Pera** golden black finishing, ceramic **Cherry** metallic steam finishing golden black collection ceramic egg **Fabergè** metallic finishing. Great creations invented by ADRIANI & ROSSI



Cherry floor big  
Q243/6X120.  
Pag. 244



DECOR  
SCOUTING  
ATELIER

Pera 65T/6X126. Pag. 244

Mela 64T/6X126. Pag. 244

# CHERRY BEST SELLER DELLA FANTASIA

BESTSELLER  
OF THE FANTASY

Cherry wall collection. Pag. 261



Cherry floor collection. Pag. 244

 **Cherry lamp small P197/6X120**  
Lampada a sospensione  
Hanging lamp  
Pag. 240

 **Cherry lamp big P196/6X150**  
Lampada a sospensione  
Hanging lamp  
Pag. 240

**CHERRY, UN'ICONA COPIATA IN TUTTO IL MONDO SIMBOLO DI FANTASIA  
E DI DESIGN, REINTERPRETATA IN FINITURA METALLICA GOLDEN BLACK.  
UTILIZZABILE COME LAMPADA, DECORO A MURO O SCULTURA A TERRA.**

CHERRY, BESTSELLER OF THE FANTASY, AN ICON REPRODUCED ALL OVER THE  
WORLD SYMBOL OF FANTASY AND DESIGN, REINTERPRETED IN METALLIC GOLDEN  
BLACK FINISHING. CAN BE USE AS A LAMP, WALL ART OR FLOOR SCULPTURE.

# IL DESIGN È UNA QUESTIONE DI EQUILIBRIO!

DESIGN IS A MATERN OF BALANCE!



OGGETTI PER OGNI SITUAZIONE DI INTERIOR,  
CAPACI DI FONDERSI ALL'AMBIENTE PER CREARE UNO STILE TOTAL LOOK.

OBJECTS FOR EVERY DESIGN SITUATION,  
CAPABLE TO MELT IN THE SETTING TO CREATE A TOTAL LOOK STYLE.

## ATELIER



 **Ambrella D184X200**  
Fioriera in metallo  
Metal flowerpot  
Pag. 267

 **Ambrella D188X220**  
Fioriera in metallo  
Metal flowerpot  
Pag. 267

 **Quinta F158X300**  
Separè stampato  
Separé booth  
Pag. 261

 **Gym big P268TX225**  
Lampada a sospensione  
Hanging lamp  
Pag. 237



GEOMETRIA SIMBOLO DI BELLEZZA  
GEOMETRY SYMBOL OF BEAUTY

**Atelier** è fusione di geometria nei volumi. Il quadro a cerchio **Giotto** stampato nei vari decori disegna la parete con immutabile bellezza. Le lampade **Babylon** in vetro soffiato di Murano, in finitura tortora e dettagli cromati oro. Vasi **Onion** in ceramica smaltata con bordatura sbalzata in platino. **Consolle 80** della collezione **Passepartout**. A sinistra lampada **Gym** in finitura antracite con sfera tortora. Porta asciugamani **Gamani** e separè **Quinta** coordinato con tappeto **Rainbow**. **Atelier** is the fusion of the geometry in the volumes. The round painting **Giotto** printed with different graphics design the wall with unchanging beauty. The **Babylon** lamps in Murano blown glass dove finishing and gold details. **Onion** vases in glazed ceramic with embossed edging platinum finishing. **Consolle 80** **Passepartout** collection. On the left **Gym** lamp finishing anthracite with dove sphere. Towel rack **Gamani** and separè booth **Quinta** matching with the **Rainbow** rug.



**Tulip 80 PATU80X168**  
Consolle in metallo  
Metal console  
Pag. 268



**Onion Q233X125**  
Vaso in ceramica  
Ceramic vase  
Pag. 247



**Babylon tortora P367X120**  
Lampada a sospensione  
Hanging lamp  
Pag. 240



**Giotto F156X160**  
Quadro sog. 2300  
Painting sub. 2300  
Pag. 254



**Gym big P268TX225**  
Lampada a sospensione  
Hanging lamp. Pag. 237

**Quinta F158X300**  
Separè stampato  
Separé booth. Pag. 261

**Gamani PAGA50X175**  
Porta asciugamani  
Towel rack. Pag. 269

# PASSEPARTOUT PROGETTO SOLUZIONE PRONTI ALL'USO

PASSEPARTOUT  
SOLUTION PROJECT  
READY TO USE



**Quinta F158X300**  
Separè stampato  
Separé booth  
Pag. 261



**Gamani PAGA50X175**  
Porta asciugamani  
Towel rack  
Pag. 269



**Brame PASP60X286**  
Specchio fumè  
Fumè mirror  
Pag. 269



**Tulip PATU80X168**  
Consolle in metallo  
Metal console  
Pag. 268



**Gruccia PAGR50X235**  
Appendiabiti  
Clothes hangers  
Pag. 269



**Nappe Q497X90**  
Pouff in gres porcellanato  
Pouf in porcelain stoneware  
Pag. 272



**LA SERIE DI VETRI SOFFIATI DI MURANO, SETUS SQUARE E MITO CROSS, VERO SIMBOLO DI DESIGN. UN MONDO DI PROGETTI REALIZZATI DA MAESTRI DELLA TRADIZIONE VENEZIANA UNICI E MODERNI**

THE COLLECTION OF MURANO BLOWN GLASS, SETUS SQUARE AND MITO CROSS, REAL SYMBOL OF DESIGN. A WORLD OF PROJECTS REALIZED BY MASTERS OF THE VENETIAN TRADITION UNIQUE AND MODERN



**Mito cross C183AX200**  
Vaso in vetro. Glass vase.  
Pag. 250

**Mito cross C183BX220**  
Vaso in vetro. Glass vase.  
Pag. 250

# CREAZIONI CULT PER SOFISTICATI ACCOSTAMENTI

CULT CREATION  
SOPHISTICATED COMBINATION



Lampade **Babylon** in vetro fumè, vasi **Setus square** in vetro tortora, vaso **Chic** in ceramica rigata bronzo. **Babylon** lamps fumé glass, **Setus square** vases dove glass and **Chic** ceramic vase ridged bronze.

**Setus square vaso in vetro C184AX200.**  
Setus square glass vase.  
Pag. 250

**Setus square vaso in vetro C184BX220.**  
Setus square glass vase.  
Pag. 250



**IDEE CREATIVE SI  
MESCOLANO NELLO STILE  
PASSEPARTOUT**

CREATIVES IDEAS MELT WITH  
THE PASSEPARTOUT STYLE

Giotto F156X160  
Quadro sog. 2300  
Painting sub. 2300  
Pag. 254



La specchiera **Brame** con specchio Fumè e struttura in metallo riflette lo spirito e gli accostamenti del progetto **Passepartout**. Le lampade **Gym** con struttura in metallo antracite e sfere in vetro di Murano soffiato nel colore tortora, si posizionano in modo eccentrico, inclinate a piacere. Quadro **Giotto** Ø 120 cm con stampa in tela poliuretanic. Fioriere **Umbrella** in metallo finitura antracite e **Hippo** small in finitura platino. The fumé mirror **Brame** with metallic structure reflects the spirit and the combination of the **Passepartout** project. The **Gym** lamp with metallic anthracite structure and dove sphere in Murano blown glass. To be placed in eccentric way and as you prefer. Painting **Giotto** Ø 120 cm printed polyurethane canvas. Planter **Umbrella** metallic finishing anthracite and **Hippo** small platinum finishing.



 **Brame PASP60X286**  
Specchio fumè  
Fumè mirror  
Pag. 269

 **Gym big P268TX225**  
Lampada a sospensione  
Hanging lamp  
Pag. 237



Venissa collection golden black. Pag. 242

QUESTIONE DI STILE  
QUESTION OF STYLE

Un'insieme di complementi e oggetti che si fondono tra di loro. A destra la specchiera con luce **Planeta** e specchio ovale fumè ad effetto sospeso nella cornice diamantata laccata in finitura nero opaco.

A combination of furnishing and objects that combines together. On the right the mirror with light **Planeta** oval shaped mirror fumè finishing hanging effect with lacquered frame matt black finishing.

 **Mirto PAMI160X445**  
Mensola  
Shelves  
Pag. 267

 **Planeta P467X300**  
Specchiera luminosa  
Luminous mirror  
Pag. 260

 **Eclipse P438X130**  
Lampada a sospensione  
Hanging lamp  
Pag. 237



Lampade **Eclipse** con sfera in vetro soffiato di Murano e struttura cromata nickel, vaso **Guest** in vetro soffiato riflettente fumè. Mensola **Mirto** in metallo verniciato antracite e consolle **Step Vase 120** della collezione **Passepartout**. Lamp Eclipse with sphere in Murano blown glass and nickel structure. **Guest** vase blown glass fumé finishing. Metallic **Mirto** shelf varnished anthracite and consolle **Step Vase 120** Passepartout collection.

 **Teca C205BX100**  
Teca portaoggetti in vetro  
Storage case in transparent glass  
Pag. 251

 **Tulip PATU30X145**  
Consolle in metallo  
Metal console  
Pag. 268

 **Guest C203X39**  
Vaso in vetro sfumato riflettente  
Vase in shaded reflective glass  
Pag. 249



 **Planeta P467X300**  
Specchiera luminosa  
Luminous mirror  
Pag. 260

 **Eclipse P438X130**  
Lampada a sospensione  
Hanging lamp  
Pag. 237

 **Mirto PAMI160X445**  
Mensola in metallo  
Metallic shelves  
Pag. 267

 **Step vase 120 PAST120X490**  
Consolle in metallo  
Metal console  
Pag. 268

 **Nice Q111/3X72**  
Vaso in ceramica  
Ceramic vase  
Pag. 268

TRA ARTE E DESIGN  
BETWEEN ART AND DESIGN

A destra il porta abiti **Gruccia** trova nella semplicità del disegno il vero uso. La ciliegia **Cherry** vera scultura in ceramica finitura oro 24 carati. La lampada **Ellen** crea un effetto angolare di grande tridimensionalità senza trascurare la forza del progetto luminoso led. On the right the clothes hang **Gruccia** finds the simplicity of the drawing, real use. The ceramic **Cherry** real sculpture in gold 24 carat finishing. The lamp **Ellen** creates a corner three dimensional effect without forgetting the strength of the luminous led project.



**Quinta F158X300**  
Separè stampato  
Separé booth  
Pag. 261



**Giotto F156X160**  
Quadro sog. 2300  
Painting sub. 2300  
Pag. 254



**Setus square C184AX200**  
Vaso in vetro tortora  
Glass vase dove color  
Pag. 250



**Tob big Q107/5RX42**  
Vaso in ceramica finitura rigata  
Ridged ceramic  
Pag. 246



**Setus square C184BX220**  
Vaso in vetro tortora  
Glass vase dove color  
Pag. 250



**LA COLLEZIONE PASSEPARTOUT  
DISEGNA LO SPAZIO, NELLA LINEA  
SOTTILE DELLA STRUTTURA DA 1 CM.**  
THE COLLECTION PASSEPARTOUT  
DESIGN THE SPACE, A THIN LINE  
OF THE 1 CM STRUCTURE.



**Gruccia PAGR50X235**  
Appendiabiti  
Clothes hangers  
Pag. 269



**Ellen P456X430**  
Lampada con struttura  
Lamp with 1 cm metallic structure  
Pag. 239



**Cherry floor big Q243/2X245**  
Ciliegie da terra  
Floor ceramic sculpture  
Pag. 244

# EMOZIONI IN UN BISTRÒ

EMOTION IN A BISTRÒ



**Tavoli bassi Bistrò PATB78X280.**  
Bistrò low table.  
Pag. 266

**Tavoli alti Bistrò PATB100X300.**  
Bistrò high table.  
Pag. 266

**VASO MITO SQUARE  
E RANOCCHIO PRINCE  
ORO ROSA**

MITO SQUARE VASE  
AND FROG PINK  
GOLD PRINCE



**Setus square C184AX200**  
Vaso in vetro tortora  
Glass vase dove color  
Pag. 250

**Setus square C184BX220**  
Vaso in vetro tortora  
Glass vase dove color  
Pag. 250

**FORME CREATIVE,  
DESIGN DA COLLEZIONE**

CREATIVE SHAPES, DESIGN COLLECTION

Vasi in vetro di Murano **Setus Cross** e **Mito Square** sono vero connubio tra design e scultura, tra modernità e tradizione all'antica lavorazione dei Maestri veneziani.

Murano glass vases **Setus Cross** and **Mito Square** are the real combination between design and sculpture, between modernity and tradition of the ancient manufacturing of the venetian Masters.



**Mito cross C183AX200**  
Vaso in vetro. Glass vase.  
Pag. 250

**Mito cross C183BX220**  
Vaso in vetro. Glass vase.  
Pag. 250

VOGUE

**Vogue small P381X300**  
Lampada a sospensione  
Hanging lamp. Pag. 236

**Vogue big P382X399**  
Lampada a sospensione  
Hanging lamp. Pag. 236



**Nappe Q497X90**  
Pouff in gres porcellanato  
Pouf in porcelain stoneware  
Pag. 272

**Como PACO40X154**  
Comodino  
Bedside tables  
Pag. 266

**Klee S153X320**  
Tappeto in ciniglia  
Chenille rug  
Pag. 263







Lampada Gym in oro rosa e sfera fumè P268/2X350.  
Gym lamp pink gold and fumé sphere. Pag. 237

**GYM - IL BILANCIERE LUMINOSO**

GYM THE LUMINOUS BALANCE

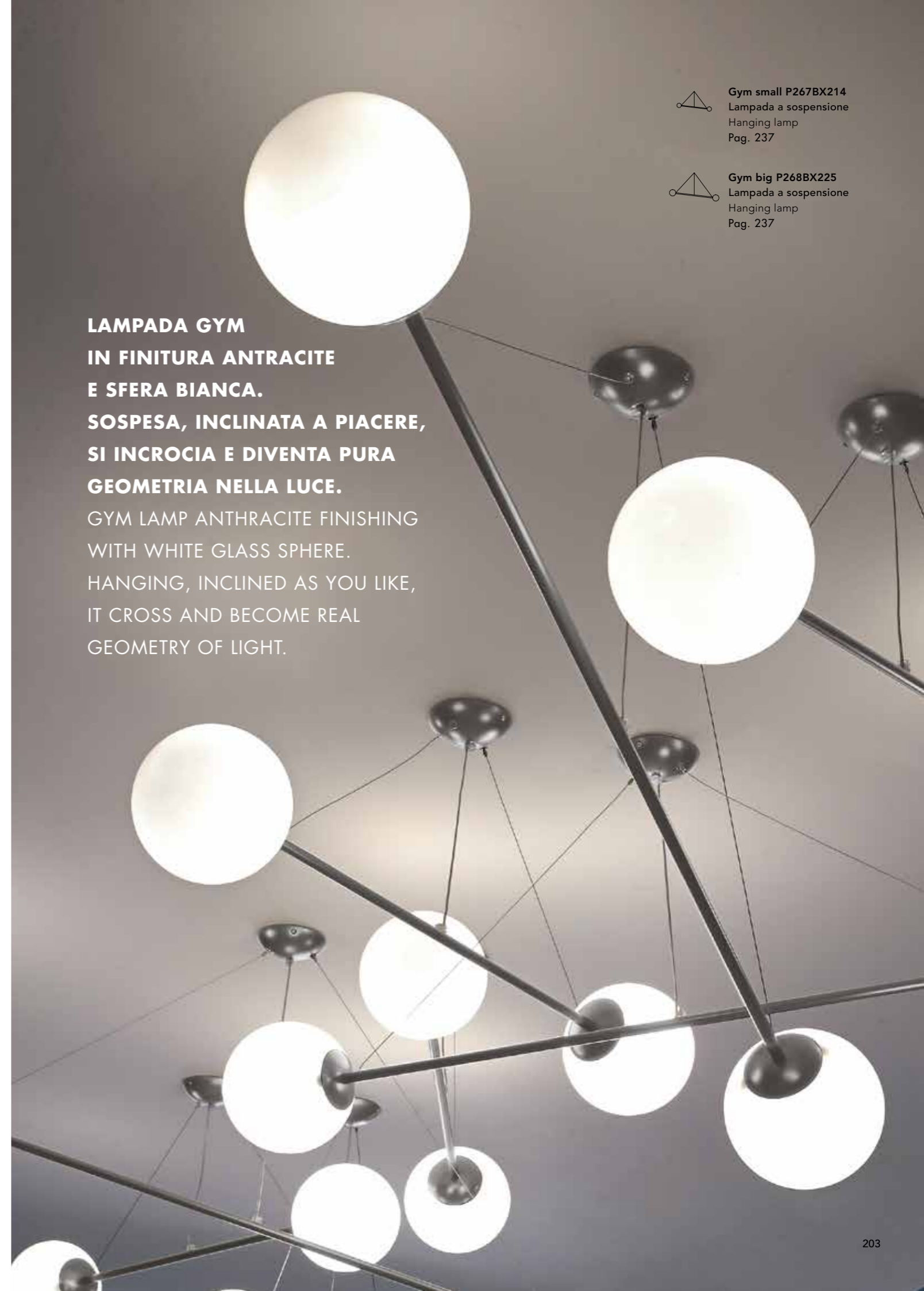
Lampada **Gym** disponibile in finitura metallo antracite e oro rosa con sfere in vetro di Murano bianche o tortora.  
**Gym** lamp available in metallic anthracite finishing and pink gold with Murano glass sphere white or dove.



 **Gym small P267BX214**  
Lampada a sospensione  
Hanging lamp  
Pag. 237

 **Gym big P268BX225**  
Lampada a sospensione  
Hanging lamp  
Pag. 237

**LAMPADA GYM  
IN FINITURA ANTRACITE  
E SFERA BIANCA.  
SOSPESA, INCLINATA A PIACERE,  
SI INCROCIA E DIVENTA PURA  
GEOMETRIA NELLA LUCE.**  
GYM LAMP ANTHRACITE FINISHING  
WITH WHITE GLASS SPHERE.  
HANGING, INCLINED AS YOU LIKE,  
IT CROSS AND BECOME REAL  
GEOMETRY OF LIGHT.

*Miss Mary*  
DESIGN

IL DESIGN SCOLPITO

THE CARVED DESIGN

**MISS MARY DESIGN È UN CONCEPT CHE TRASFORMA GLI ARREDI, I COMPLEMENTI, GLI OGGETTI IN VERE SCULTURE. UN MOBILE CON BREVETTO DI INVENZIONE DEPOSITATO. COMPLEMENTI SCOLPITI A MANO PER CREARE UN'IMMAGINE UNICA E IRRIPETIBILE. UN MOBILE SU MISURA NELLE LACCATURE METALLICHE, LUCIDE E OPACHE A PIACERE.**

MISS MARY DESIGN IS A CONCEPT THAT TRANSFORM THE FURNITURE, THE ACCESSORY, THE OBJECTS IN REALS SCULPTURE. A PATENTET ITEM, CARVED BY HAND WHICH GIVES AN IMAGE OF VOLUMES TO CREATE A UNIQUE AND UNREPETEABLE FURNITURE. A CUSTOM FURNITURE IN THE METALLIC GLOSSY OR MATT VARNISH UPON REQUEST.



Appendiabiti Up PAUP25X144.  
Clothes hangers Up. Pag. 269

Specchiera Valentino VA50/22X950.  
Valentino mirror. Pag. 270



# EMOZIONI IN SUPERFICIE

SURFACE EMOTIONS



Vasi Bouble. Bouble vases. Pag. 251

Il vaso **Bouble** ritrova emozioni creative nella magia del vetro Blu e nei riflessi dell'acciaio inox. A destra specchiera **Valentino** della collezione **Miss Mary Design** scolpita a mano con specchio fumè e laccatura metallica golden black. **Bouble** vase find the creative emotions in the charm of the blue glass. **Valentino** mirror and made carved from collection **Miss Mary Design** with mirror fumé glass and metallic varnish golden black.



Specchiera Valentino VA50/22X950.  
Valentino mirror. Pag. 270

Quadri Amadeus.  
Amadeus paintings. Pag. 260



# IL DESIGN SCOLPITO

THE CARVED DESIGN

Geometrie e modernità del legno. I quadri con luce **Amadeus** creano vera scultura alle pareti. La mensola **Line** nella finitura golden black diventa all'occorrenza piano scrittoio. Geometry and modernity of the wood. The painting with light **Amadeus** in the metallic finishing create a real sculpture in the wall. The shelf **Line** in golden black finishing becomes if necessary a writing desk.



Libreria Book. Book bookcase. Pag. 270

Vasi in vetro Poline. Poline glass vases. Pag. 249

**Poline C201AX40**  
Vaso in vetro  
Glass vase  
Pag. 249

**Poline C201BX35**  
Vaso in vetro  
Glass vase  
Pag. 249

## POLINE VASES



**LA GRANDE  
SPECCHIERA  
SAGOMATA LOOK  
RISPECCHIA  
E DISEGNA LO SPAZIO.  
COME TUTTI I MOBILI  
MISS MARY DESIGN  
POTRÀ AVERE MISURE E  
FINITURE DIVERSE.  
SPECCHIO IN FINITURA  
FUMÈ E VERNICIATURA  
METALLICA IN FINITURA  
GOLDEN BLACK.**

THE BIG SHAPED MIRROR  
LOOK REFLECTS AND  
DESIGNS THE SPACE.  
LIKE FOR THE ALL  
COLLECTION MISS MARY  
DESIGN THE FURNITURE  
CAN HAVE CUSTOM  
SIZE AND FINISHING.  
FUMÉ MIRROR METALLIC  
STRUCTURE GOLDEN  
BLACK FINISHING.

Specchiera Look LO22/22X1950. Look mirrors . Pag. 270

Tappeto Lovac S162X800. Lovac rug. Pag. 264

Fioriere Ambrella. Ambrella flowerpot. Pag. 267



Madia Lampo LA18/149X1800. Lampo sideboard . Pag. 270

# VERA SCULTURA

REAL SCULPTURE

**LA MADIA BOOK APERTA  
CON RIPIANO SAGOMATO  
INCLINATO,  
È VERA SCULTURA.**

**GLI ELEMENTI STRUTTURALI  
SONO EVIDENZIATI  
DAL RIPIANO IN VETRO  
TRASPARENTE,  
SPESSORE 14 MM,  
SOSPESO AD INCASTRO.**

THE BOOKCASE BOOK  
WITH SHAPED  
RECLINED SHELF  
IS REAL SCULPTURE.

THE STRUCTURAL ELEMENTS  
ARE UNDERLINED BY THE  
TRANSPARENT GLASS  
SHELF, THICKNESS 14 MM,  
INTERLOCKING SYSTEM.

# MISS MARY QUADRO SCULTURA

SCULPTURE PAINTING

La materia trasforma il decoro inciso a mano  
incorniciando una vera scultura con riflessi  
nelle finiture metalliche.

The material transform the handmade decoration  
framing a real sculpture with metallic reflection.

Comodino **Ubik** UB60/45X200. **Ubik** bedside table. Pag. 271

### INIFINITE SOLUZIONI ENDLESS SOLUTIONS

La mensola **Line** a forte spessore si trasforma in piano scrittoio diventando un forte segno nella parete. Il pouf **Nappe** in gres porcellanato in colore antracite diventa facile seduta all'uso. Il monolite **Ubik** si trasforma in comodino su ruote. Lampada **Caminia** in vetro sfumato rosa con basamento in oro si abbina alle sospensioni **Lord** Rosa nelle stesse finiture. A sinistra lampada a sospensione **Geo** in finitura metallo oro rosa con sfera in vetro opale bianco di Murano. Vasi vetro **Absolute** In finitura ametista, tappeto **Ormus** grey **Hippo** small e big in finitura golden black. The **Line** shelf great thickness becomes a writing desk, a strong sign in the wall. **Nappe** pouff stoneware anthracite color becomes a seating. The monolith **Ubik** becomes a bed side table on wheels. **Caminia** lamp in blown glass with gold support matches with the hanging lamp **Lord** Pink. On the left hanging lamp **Geo** metallic support pink gold finishing white sphere Murano opal glass. **Absolute** glass vases amethyst color, **Ormus** grey. Hippo small and big golden black finishing.



**Geo** P425/2X520  
Lampada a sospensione in oro rosa  
Hanging lamp pink gold  
Pag. 237



**Absolute** C200CX48  
Vaso in vetro Ametista  
Amethyst glass vase  
Pag. 248

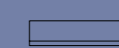

**Line** L118/44X600  
Mensola golden black  
Shelves goldenblack finishing  
Pag. 270



Vasi **Bouble** in vetro soffiato di Murano, con struttura in legno verniciata metallico golden black.

Quadro materico **Murales** con cornice in golden black.

**Bouble** vases in Murano blown glass, wood structure metallic varnish golden black.

Materic **Murales** with golden black frame.

Libreria bifacciale Book MM22/22X2150. Bookcase Book double sided. Pag. 270



Vaso in vetro blu Bouble C206BX220.  
Bouble glass vase blue.  
Pag. 251

Vaso in vetro Bouble C206AX200.  
Bouble glass vase blue.  
Pag. 251



Quadro Oceano. Pag. 256

Hippo turchese Q440/MX240.  
Torquoise Hippo.  
Pag. 243



LIBRERIA MISS MARY  
MISS MARY LIBRARY

Il sistema libreria **Miss Mary** è unico, perché trova la vera forza nella semplicità del disegno, la forma quadrangolare si rafforza ancor più nelle linee avendo un sistema di fissaggio completamente a scomparsa. I ripiani in vetro trasparente, spessore 14mm, disegnano con leggerezza lo spazio della voluminosa cornice. The **Miss Mary** bookcase system is unique, as it finds his strength in the simplicity of the drawing, the square shape take his strength also in the lines with a hidden fixing system. The transparent glass shelves, thickness 14mm, draw with lightness the space voluminous frame.



Book MM22/22X2150  
Libreria  
Bookcase  
Pag. 270



Elite C202AX30  
Vaso in vetro  
Glass vase  
Pag. 248



Hippo Wagon Q452/2X380  
Scultura in ceramica oro antico  
Ceramic antique gold sculpture  
Pag. 243



Four season F137MX590  
Quadri materici  
Materic paintings  
Pag. 257





**MONOLITE CRAZY SCOLPITO  
CON VANO PORTA ACCESSORI,  
LA FILOSOFIA MISS MARY  
È DI TRASFORMARE UN OGGETTO D'USO  
IN ELEMENTO SCULTOREO.**

MONOLITH CRAZY CRAVED WITH POCKET  
FOR ACCESSORY, THE MISS MARY PHILOSOPHY  
IS TO TRANSFORM AN OBJECT IN A SCULPTURE.

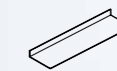

**Segno**  
Mensola  
Shelves  
Pag. 267



**Round PATR40X189**  
Tavolini rotondi  
Coffee tables rounder  
Pag. 266



**Crazy CR32/56X1500**  
Contentore  
Boxe  
Pag. 271



SPAZIO AL DETTAGLIO  
 DETAILED SPACE

La cura del dettaglio e del design. Il piano di lavoro **Crazy** è leggermente inclinato nella parte finale, creando spazio utile al passaggio di cavi. Il monolite è rastremato nella parte finale per creare un volume più disegnato e meno ingombrante. Attention to the detail and to the design. The **Crazy** worktop is slightly reclined in the final part, creating the space for the lighting cable. The monolith is tapered in the final part to create a more designed volume and a space saving design.



 Caminia P451X190  
 Lampada da tavolo  
 Table lamp  
 Pag. 241

**IL TAVOLINO SLIDE  
TRASFORMA I VOLUMI SU RUOTE  
IN PIANI DI SERVIZIO O SEDUTA AGLI OSPITI.  
IL PIANO SOVRASTANTE LACCATO  
HA IL BASAMENTO IN ACCIAIO INOX SATINATO.**

THE SLIDE TABLE  
TRANSFORM THE VOLUMES ON WHEELS  
IN SERVICE TABLE OR SEATING FOR THE GUESTS.  
THE OVERLYING LACQUERED SURFACE  
HAS THE INOX STRUCTURE.



Lord fumè P359X215  
Lampada a sospensione  
Hanging lamp  
Pag. 240



Stone ALC028/2X79  
Sasso a muro oro  
Ceramic wall stone gold  
Pag. 261



Slide SL137/41X1400  
Tavolino  
Coffee table  
Pag. 272



Boss S137X450  
Tappeto grigio  
Rug grey  
Pag. 262





Tavolino Double D012/35X1200  
Double coffee tables  
Pag. 272

Vassoi **Porto** in tre misure con cornice in legno laccato nero opaco e piano metallo verniciato.  
**Teca** in vetro bordato metallo con ranocchio  
**Prince** in finitura oro rosa e corona in oro 24 carati.  
**Porto** tray available in three sizes with lacquered matt black wood frame and varnished metal on top.  
**Teca** storage case metallic structure with frog **Prince** pink gold color with crown 24 carat gold.

**DETTAGLIO DELLE SCULTURE MISS MARY.  
ESEGUITO MANUALMENTE,  
RENDE UNICO E IRRIPETIBILE  
OGNI MOBILE, CREANDO  
VOLUMI MASSICI E LACCATURE  
CON EFFETTO LEGNO.**

DETAIL OF THE MISS MARY SCULPTURES.  
HANDMADE SCULPTURES  
MAKE UNIQUE AND UNREPEATABLE  
EVERY FURNITURE CREATING VOLUMES  
AND VARNISH WOOD EFFECT.



SCULTURE  
CHE ARREDANO

DECORATING SCULPTURE

**COFFEE TABLE DOUBLE DELLA COLLEZIONE MISS MARY DESIGN.  
SEMPLICITÀ DEL DESIGN IN QUESTO MOBILE SU RUOTE CON RIPIANO  
DI SERVIZIO ESTRAIBILE (movimento slow motion)**

COFFEE TABLE DOUBLE FROM THE MISS MARY DESIGN COLLECTION.  
THE SIMPLICITY OF THE DESIGN IN THIS FURNITURE ON WHEELS WITH INVISIBLE  
SLIDING SHELF (slow motion)

IL TAVOLO GLORY  
THE GLORY TABLE

Il tavolo **Glory** è a misura, in appoggio ai cilindri in metallo verniciati, piano top verniciato metallico a spessore 4 cm con bordo a doppia inclinatura. Gli angoli svasati creano una sorta di struttura ottagonale. Il basamento **Trave** è un monolite senza ante con un fianco laterale rastremato verniciato in finitura metallica golden black. The **Glory** table is to length, leaning on the metallic cylinder there is a metallic surface thickness 4cm edge with double inclination. The flaring corners create an octagonal structure. The structure is a monolith with a tapered side. The base **Trave** varnished in metallic golden black finishing.



**Glory GL15/75X1100**  
Tavolo  
Table  
Pag. 272

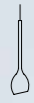

**Vanille P432/1X140**  
Lampada a sospensione  
Hanging lamp  
Pag. 240

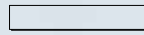

**Trave TR32/56X1000**  
Contentore  
Boxe  
Pag. 271





**Murales F124MX150**  
Quadro materico  
Materic paintings  
Pag. 257





**Klee S166X960**  
Tappeto in viscosa  
Viscose rug  
Pag. 263



 **Murales F124MX150**  
Quadro materico  
Materic paintings  
Pag. 257

 **Amal Q405/6X102**  
Sculptura in ceramica  
Ceramic sculpture  
Pag. 245

 **Pongo C179X150**  
Vaso in vetro  
Glass vase  
Pag. 248

 **Bouble C206BX220**  
Vaso in vetro  
Glass vase  
Pag. 251



Tavolo Glory GL15/75X1100  
Glory tables  
Pag. 272

Coordinati alle finiture metalliche, i quadri materici **Murales**, il tappeto **Klee** lascia il segno al decoro, il vaso **Amal** eclettico e rigoroso, in ceramica verniciata, diventa contrasto con il vaso in vetro di murano fumè, **Pongo**. Nella stessa finitura di vetro fumè di Murano il vaso **Bouble** con struttura in acciaio satinato. Matching in the metallic finishing, materic painting **Murales**, **Klee** rug leave the sign to the decoration, the vase **Amal** eclectic and rigorous in lacquered ceramic creates contrast with the Murano glass fume color **Pongo**. In the same finishing Murano glass fumè **Bouble** with inox structure.

UNO  
STILE  
CHE  
LASCIA  
IL SEGNO

A STYLE THAT MAKES AN IMPRESSION





Lampada Vanille P432/6X160. Vanille lamp. Pag. 240

Vassoio **Porto** nelle tre misure in mdf laccato nero opaco e interno metallico a 45° verniciato golden black. **Teca** portaoggetti in vetro trasparente spessore 3 mm con bordo metallico spessore 4 mm e struttura antracite. Adatta per oggetti, candele, piante. Qui sopra le lampade **Vanille** in ceramica finitura metallica golden black. Mdf **Porto** tray available in three sizes with lacquered matt black and varnished metal on top at 45°. **Teca** storage case transparent glass thickness 3 mm metallic edge thickness 4mm athracite structure. Suitable for objects, candles, plants. Above **Vanille** ceramic lamp metallic golden black finishing.

 **Porto D189/AX70**  
Vassoio. Tray.  
30x30  
Pag. 272

 **Porto D189/BX80**  
Vassoio. Tray.  
40x40  
Pag. 272

 **Porto D189/CX90**  
Vassoio. Tray.  
60x30  
Pag. 272

 **Teca C205BX100**  
Teca portaoggetti in vetro  
Storage case in transparent glass  
Pag. 251



# PORTO, SERVIZIO DI QUALITÀ

PORTO - QUALITY SERVICE

LAMPADE - LAMPS

**VOLARE SOUND**

pag. 170

Lampada in tessuto di lana vergine certificato con forma ellittica. Sfera coprilampada in vetro di Murano.  
Cavo in tessuto antracite. Consigliata per assorbimento sonoro.  
Virgin wool certified elliptical fabric lamp. Murano glass sphere. Textile charcoal cable.  
Recommended for sound absorbing.

- Tessuto grigio chiaro / Light grey fabric
- Tessuto antracite / Anthracite fabric
- Tessuto bordeaux / Bordeaux fabric
- Vetro tortora / Fumé glass
- Luce Ø 20 cm / 1xE27-52 W HES

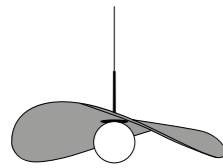

**VOLARE SOUND SMALL**  
P383/SX260  
120 x 80 cm

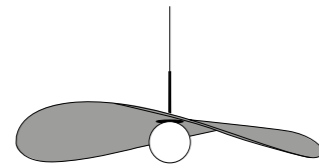

**VOLARE SOUND BIG**  
P384/SX360  
190 x 110 cm

**VOGUE PLISSÉ**

pag. 81 - 109 - 135

Lampada a sospensione in tessuto plissettato con sfera in vetro di Murano tortora.  
Colori: grigio chiaro, grigio scuro, bordeaux.  
Hanging lamp in pleated woven with sphere lamp cover in Murano glass fumé color.  
Colors: light grey, dark grey, bordeaux.

- Tessuto grigio chiaro / Light grey fabric
- Tessuto grigio scuro / Dark grey fabric
- Tessuto bordeaux / Bordeaux fabric
- Vetro tortora / Fumé glass
- Luce Ø 20 cm / 1xE27-52 W HES

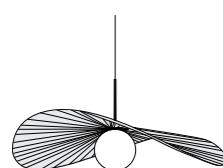

**VOGUE PLISSÉ SMALL**  
P445X320  
120 x 80 cm

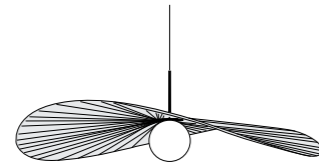

**VOGUE PLISSÉ BIG**  
P446X540  
190 x 110 cm

**VOGUE**

pag. 33 - 148 - 158 - 201

Lampada a sospensione in metallo verniciato oro, antracite o grigio perla.  
Sfera coprilampada in vetro di Murano in colore bianco.  
Metal Hanging lamp in gold finish, anthracite or pearl grey varnished.  
Sphere lamp cover in Murano glass in white color.

- Cod. /X Antracite / Anthracite
- Cod. /2X Oro / Gold
- Cod. /CX Grigio perla / Pearl grey
- Vetro bianco / White glass
- Luce Ø 20 cm / 1xE27-52 W HES

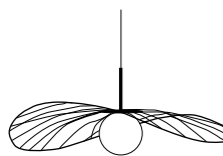

**VOGUE SMALL**  
P381X300 antracite/anthracite  
P381/2X300 oro/gold  
P381/CX300 grigio perla / pearl grey  
120 x 80 cm

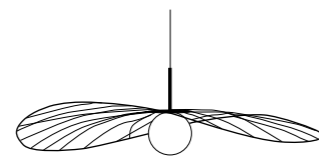

**VOGUE BIG**  
P382X399 antracite/anthracite  
P382/2X399 oro/gold  
P382/CX399 grigio perla / pearl grey  
190 x 110 cm

**FLOU**

pag. 16 - 137 - 138

Lampada a sospensione in vetro di Murano con sfumatura colore. Colori disponibili: bianco, fumé.  
A richiesta disponibile nei colori ametista e acquamarina.  
Hanging Murano glass lamp shaded colors. Available colors: white, fumé.  
Upon request available colors: aquamarine and amethyst.

- Di serie / Standard
- Bianco / White
- Fumé / Fumé
- Su richiesta / Upon request
- Blu acquamarina / Aquamarine blue
- Ametista / Amethyst
- Luce 1xE27-52 W HES



**FLOU**  
P433X290  
H 60 Ø 35 cm

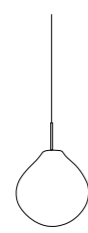

**FLOU**  
P434X290  
H 45 Ø 50 cm

LAMPADE - LAMPS

**GYM**

pag. 185 - 202 - 203 - 216

Lampada a sospensione in metallo verniciato antracite opaco con sfera coprilampada in vetro di Murano colore tortora.  
Solo per modello GYM BIG: disponibile anche in metallo verniciato oro rosa con sfera coprilampada in vetro bianco.  
Hanging lamp in matt black anthracite varnished metal with sphere lamp cover in Murano glass fumé color.  
Only for GYM BIG model: also available in pink gold varnished metal with sphere lamp cover in Murano glass white color.

- Cod. /X Antracite opaco / Matt anthracite
- Vetro bianco / White glass
- Vetro tortora / Fumé glass
- Cod. /2X Oro rosa lucido / Glazed pink gold
- Vetro bianco / White glass
- Luce Ø 20 cm / 1xE27-52 W HES

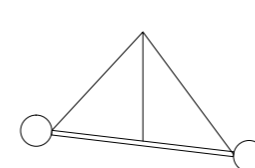

**GYM SMALL**  
P267BX214 sfera bianca /white sphere  
P267TX214 sfera tortora /dove sphere  
L 110 H 400 cm

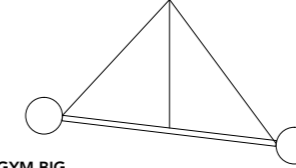

**GYM BIG**  
P268BX225 sfera bianca /white sphere  
P268TX225 sfera tortora /dove sphere  
P268/2X350 oro rosa / pink gold  
L 150 H 400 cm

**VIEW**

pag. 51 - 104

Lampada a sospensione con struttura antracite e sfera in vetro tortora oppure struttura oro rosa e sfera in vetro bianco.  
Hanging lamp with anthracite structure and sphere in fumé or rose gold structure with white glass sphere.

- Cod. /X Antracite opaco / Matt anthracite
- Vetro tortora / Fumé glass
- Cod. /2X Oro rosa lucido / Glazed pink gold
- Vetro bianco / White glass
- Luce Ø 20 cm / 1xE27-52 W HES

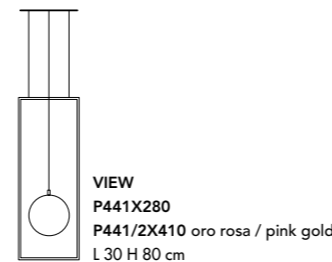

**VIEW**  
P441X280  
P441/2X410 oro rosa / pink gold  
L 30 H 80 cm

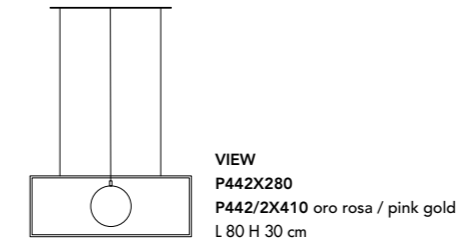

**VIEW**  
P442X280  
P442/2X410 oro rosa / pink gold  
L 80 H 30 cm

**ECLYPSE**

pag. 119 - 195

Lampada a sospensione con struttura titanio e sfera in vetro tortora oppure struttura oro rosa e sfera in vetro bianco. Cavo in tessuto grigio chiaro.  
Hanging lamp titanium structure glass dove sphere or with pink gold structure glass white sphere.  
Light grey fabric cable.

- Cod. /X Titanio / Titanium
- Vetro tortora / Fumé glass
- Cod. /2X Oro rosa lucido / Glazed pink gold
- Vetro bianco / White glass
- Luce Ø 20 cm / 1xE27-52 W HES

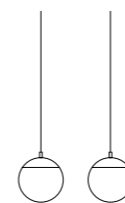

**ECLYPSE**  
P438X130  
P438/2X150 oro rosa / pink gold  
Ø 20 cm

**GEO**

pag. 107

Lampada a sospensione con struttura antracite e sfera in vetro tortora oppure struttura oro rosa e sfera in vetro bianco.  
Hanging lamp anthracite structure glass fumé sphere or with pink gold structure glass white sphere.

- Cod. /X Antracite opaco / Matt anthracite
- Vetro tortora / Fumé glass
- Cod. /2X Oro rosa lucido / Glazed pink gold
- Vetro bianco / White glass
- Luce Ø 20 cm / 1xE27-52 W HES



**GEO**  
P425X340  
P425/2X520 oro rosa / pink gold  
L 30 H 150 cm



LAMPADE - LAMPS

DADA

Lampada con struttura snodabile in metallo cromato oppure oro. Coprilampada in vetro bianco.  
Lamp with adjustable chromed or gold metal structure. Glass lampshade color white.

pag. 100 - 101

Metallo cromato  
Chrome

Oro  
Gold

Vetro bianco  
White glass

Luce 1xMax 33W  
220-240V-50Hz

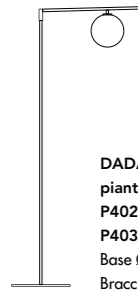

**DADA FLOOR**  
piantana / floor lamp  
P402X215 metallo cromato/chrome  
P403X264 oro /gold  
Base Ø 25 H 118,5 cm  
Braccio L 42,5 cm Sfera Ø 14

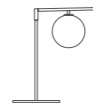

**DADA TABLE**  
da tavolo / table lamp  
P400X172 metallo cromato/chrome  
P401X196 oro /gold  
Base Ø 20 H 40 cm  
Braccio L 26 cm Sfera Ø 14

DANISH

Lampada in metallo cromato o in bronzo. Paralume in metallo nero lucido.  
Lamp with chromed metal structure or bronze. Glossy black metal lampshade.

pag. 9 - 98 - 99

Metallo cromato  
Chrome

Bronzo  
Bronze

Vetro bianco  
White glass

Luce 1XE27 60W

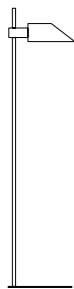

**DANISH FLOOR**  
piantana / floor lamp  
P461X298 cromo/chrome  
P462X298 bronzo/bronze  
Base Ø 30 H 130 cm  
Paralume / Lampshade L 23 cm

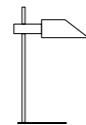

**DANISH TABLE**  
da tavolo / table lamp  
P459X172 cromo/chrome  
P460X172 bronzo/bronze  
Base Ø 23 H 55 cm  
Paralume / Lampshade L 20 cm

PEARL

Lampada con paralume cono in tessuto bianco o nero. Base in ceramica smaltata bianco/platino o nero/platino.  
Lamp with textile lampshade white or black color. Glazed ceramic vase white/platinum or black/platinum.

pag. 176 - 177

Nero / platino  
Black / platinum

Bianco / platino  
White / platinum

Luce 1xE27-52 W HES

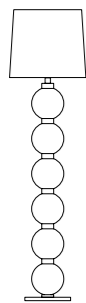

**PEARL FLOOR**  
piantana / floor lamp  
P282X530  
Base Ø 28 H 180 cm  
Paralume / Lampshade Ø 55 H 35 cm



**PEARL TABLE**  
da tavolo / table lamp  
P281X295  
Base Ø 23 H 125 cm  
Paralume / Lampshade Ø 32 H 56 cm

PLISSY

Piantana in tessuto plissettato colore grigio chiaro.  
Floor lamp pleated woven light grey color.

pag. 127 - 134

Luce 3XE27

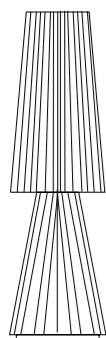

**PLISSY**  
P455X530  
Base Ø 46 H 156 cm

LAMPADE - LAMPS

ELLEN

Lampada con struttura da 1 cm in metallo antracite verniciato a polveri. Luce LED su un lato.  
Lamp with 1 cm metallic structure powder varnished anthracite. LED light on one side.

pag. 113 - 197

LED 10 WAT 3000K

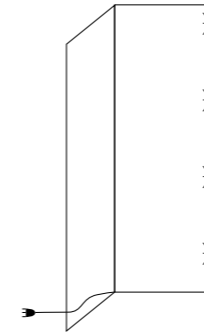

**ELLEN**  
P456X430  
L 50 P 50 H 150 cm

WINDOW

Applique in metallo.  
Wall metallic lamp.

pag. 17 - 114

Antracite  
Anthracite

Oro rosa  
Pink gold

Luce LED 7 WAT 3000K



**WINDOW antracite / anthracite**  
P457X310  
L 25 H 100 cm

**WINDOW oro rosa / pink gold**  
P458X390  
L 25 H 100 cm

TOBY

Lampada a sospensione in metallo colore bronzo o nero.  
Hanging metallic lamp bronze or black color.

pag. 34 - 41

Bronzo  
Bronze

Nero  
Black

Luce 1XLED 1W Warm



**TOBY bronzo / bronze**  
P448X98  
Ø 2,5 H 40 cm



**TOBY nero / black**  
P447X98  
Ø 2,5 H 40 cm

ROSY GOLD

Lampada a sospensione in vetro di Murano finitura tortora con particolare in oro. Cavo in tessuto antracite.  
Hanging lamp in Murano glass finishing dove color with gold details. Textile charcoal cable.

pag. 164

Tortora  
Dove color

Luce 1XE27 42W



**ROSY GOLD**  
P376X159  
Ø 15 H 45 cm

LAMPADE - LAMPS

**LORD**

pag. 166 - 167 - 227

Lampada a sospensione in vetro di Murano in finitura rosa sfumato o tortora con particolare in oro.  
Cavo in tessuto antracite.  
Murano glass hanging lamp finishing pink shaded glass or dove color with a gold detail. Textile charcoal cable.

Rosa sfumato  
Pink shade   
Tortora  
Dove color   
Luce 1XE27 42W

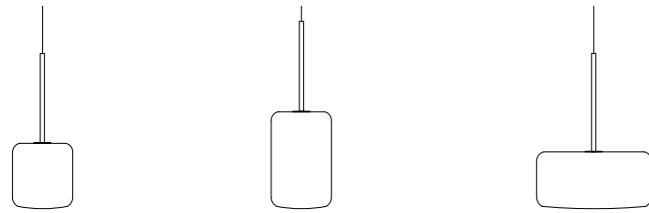

**LORD SMALL**  
P358X185  
Ø 21 H 23 cm

**LORD MEDIUM**  
P359X215  
Ø 21 H 34 cm

**LORD BIG**  
P360X250  
Ø 40 H 20 cm

**BABYLON**

pag. 67 - 97 - 184

Lampada a sospensione in vetro di Murano in finitura oro e tortora con particolare in oro.  
Cavo in tessuto antracite.  
Murano glass hanging lamp finishing dove color or gold with gold details. Textile charcoal cable.

Tortora  
Dove color   
Oro  
Gold   
Luce 1XE27 42W



**BABYLON TORTORA**  
P367X120  
Ø 12 H 27,80 cm

**BABYLON GOLD**  
P368X150  
Ø 12 H 27,80 cm

**VANILLE**

pag. 234

Lampada a sospensione in ceramica verniciata opaca golden black, silver black o nei colori opachi RAL.  
Hanging ceramic lamp varnished matt golden black or silver black or in the RAL colors.

Cod. /1X RAL opaco  
Matt RAL   
Cod. /6X Golden black   
Silver black   
Luce 1XE27 42W

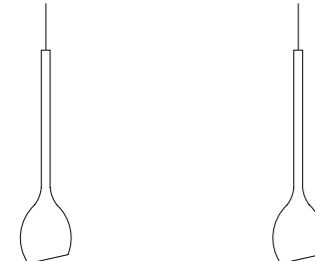

**VANILLE**  
P432/1X140  
Ø 25 H 95 cm

**VANILLE**  
P432/6X160 golden black/silver black  
Ø 25 H 95 cm

**CHERRY**

pag. 181

Lampada a sospensione con supporto in metallo, ciliegia in ceramica golden black o bordeaux lucido.  
Hanging lamp with metal stand, golden black or glazed bordeaux ceramic cherry.

Cod. X Bordeaux lucido  
Glazed bordeaux   
Cod. /6X Golden black   
Luce 1XE27 - 52 W HES

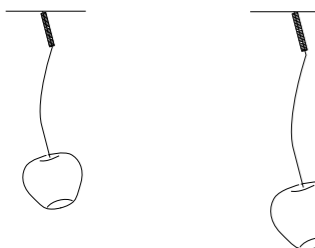

**CHERRY LAMP SMALL**  
P197X120 bordeaux  
P197/6X120 golden black  
Ø 26 H 97 cm

**CHERRY LAMP BIG**  
P196X150 bordeaux  
P196/6X150 golden black  
Ø 43 H 106 cm

LAMPADE - LAMPS

**TORCELLO**

pag. 175

Luce 1xE14 28W

Lampada a sospensione in vetro di Murano con decoro antico colori veneziani particolari in oro. Cavo in tessuto antracite.  
Murano glass hanging lamp with antique decoration venetians colors, gold details. Textile charcoal cable.

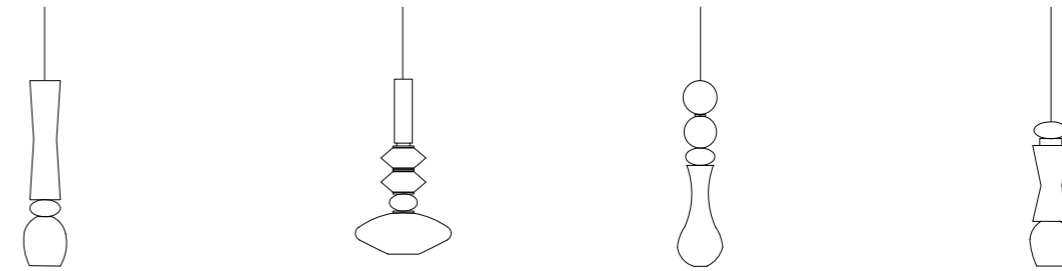

**TORCELLO A**  
P372X190  
H 54 Ø 13 cm

**TORCELLO B**  
P373X190  
H 51 Ø 28 cm

**TORCELLO C**  
P374X190  
H 54 Ø 12 cm

**TORCELLO D**  
P375X190  
H 42 Ø 12 cm

**PLANETA TABLE**

pag. 168

Specchiera luminosa in legno verniciato nero opaco e specchio antracite fumè sp. 5 mm con bordo a filo lucido.  
Luminous wood mirror varnish matt black, fumè anthracite mirror thnk 5mm shiny edge.



**PLANETA TABLE**  
P463X220  
L 22 H 22 cm

Luce 12V 15W

**FOLLOW ME**

pag. 24

Lampada ricaricabile in metallo con luce LED, basamento magnetico.  
Rechargeable metallic lamp with LED light, magnetic base.  
Adatta anche per uso esterno. Also suitable for outdoor use.



**FOLLOW ME**  
P469X180  
Ø 10 H 30 cm

**CAMINIA**

pag. 73 - 79 - 165 - 217 - 225

Luce 1XG9

Lampada da tavolo con base in metallo e paralume in ceramica o vetro rosa.  
Table lamp metallic base lampshade in ceramic or in pink glass.

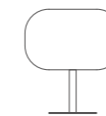

**CAMINIA** Ø 21 H 30 cm  
P451X190 base in oro,  
paralume in ceramica oro.  
Gold base,  
ceramic gold lampshade

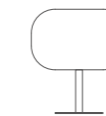

**CAMINIA** Ø 21 H 30 cm  
P449X190 base oro rosa,  
paralume in ceramica oro rosa  
Pink gold base,  
ceramic pink gold lampshade.

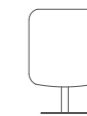



**CAMINIA** L 22 H 30 cm  
P450X180 base in antracite,  
paralume in vetro rosa opalino.  
Anthracite base,  
pink opal glass lampshade.

**MINI DIZZI e DIZZI**

pag. 91 - 121

Lampada da tavolo in vetro di Murano soffiato in bianco sfumato o fumè sfumato.  
Table lamp Murano blown glass white shaded color or fumè shaded color.

Bianco sfumato  
White shade   
Fumè sfumato  
Fumè shade 

DIZZI Luce 1XE27  
MINI DIZZI Luce 1XG9

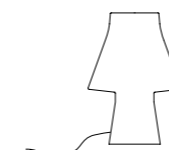

**MINI DIZZI**  
P439X130  
Ø 22 H 32 cm

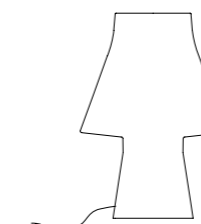

**DIZZI**  
P440X200  
Ø 35 H 50 cm

CERAMICHE - CERAMICS

VENISSA collection

pag. 33 - 70 - 123 - 153 - 192

Vaso in ceramica decorata finitura golden black, silver black o nero. Due vasi solo finitura bianca.  
Handmade decorated ceramic golden black, silver black, black finishing. Two vase only white finishing.

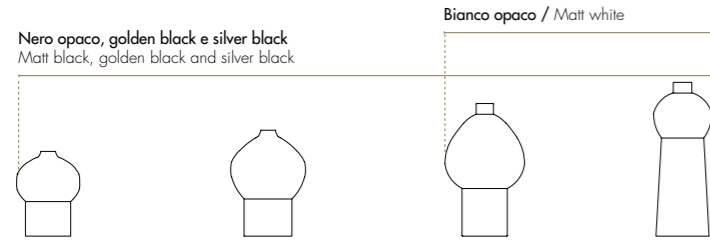

**VENISSA**  
Q481/3X34  
Q481/6X45  
Ø 24 H 30 cm

**VENISSA**  
Q482/3X40  
Q482/6X50  
Ø 32 H 38 cm

**VENISSA**  
Q483/3X50  
Q483/6X60  
Ø 32 H 48 cm

**VENISSA**  
Q484/3X60  
Q484/6X70  
L 30 P 30 H 60 cm

colori opachi / colors matt  
golden black, silver black

Cod. /3X Nero opaco  
Matt black

Bianco opaco  
Matt white

Cod. /6X Golden black

Silver black

PASSADE collection

pag. 31 - 66 - 68 - 108 - 147

Vaso in ceramica in finitura oxyd in platino anticato, nero opaco, giallo o bordeaux.  
Ceramic vase in oxyd antique platinum, matt black, yellow or bordeaux finishing.



**PASSADE**  
Q211X52  
Q211/3X52  
Q211/8X124  
Ø 28 H 22 cm

**PASSADE**  
Q212X52  
Q212/3X52  
Q212/8X124  
Ø 19 H 30 cm

**PASSADE**  
Q209X52  
Q209/3X52  
Q209/8X124  
Ø 20 H 42 cm

**PASSADE**  
Q210X72  
Q210/3X72  
Q210/8X142  
Ø 24 H 52 cm

**PASSADE**  
Q208X72  
Q208/3X72  
Q208/8X142  
Ø 23 H 49 cm

smaltata/glazed  
nero opaco/matt black  
oxyd

Cod. X Giallo lucido  
Glazed yellow

Bordeaux lucido  
Glazed bordeaux

Cod. /3X Nero opaco  
Matt black

Cod. /8X Oxyd platino anticato  
Oxyd antique platinum

ORIZZONTE collection

pag. 19

Vaso in porcellana decorato e dipinto a mano.  
Porcelain vase decorated and handpainted.

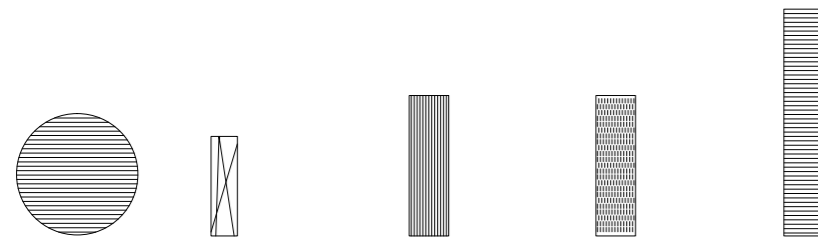

**SALLY**  
Q489X85  
Ø 42 cm

**PUNTO**  
Q488X70  
Ø 9 H 34 cm

**LINEA**  
Q486X110  
Ø 13,5 H 48 cm

**FOSSIL**  
Q487X110  
Ø 13,5 H 48 cm

**STRATO**  
Q485X126  
Ø 12 H 78 cm

BAMBOO collection

pag. 95

Vaso in ceramica nelle finiture metalliche: bronzo, rame, ruggine, metallico, golden black e nero opaco.  
Ceramic vase in different metal finishing: copper, bronze, metallic, rust, golden black and matt black.

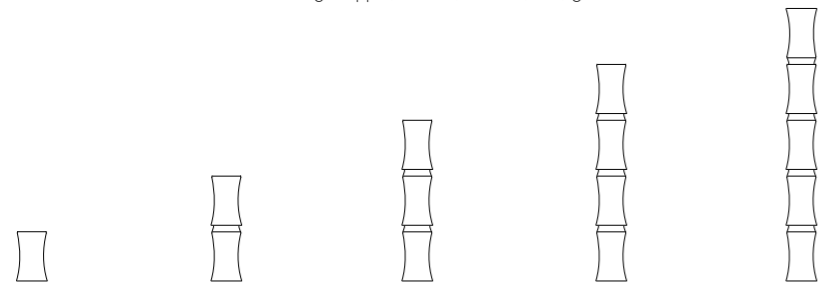

**BAMBOO**  
Q490/3X24  
Q490/5X28  
Q490/6X28  
Ø 10 H 17 cm

**BAMBOO**  
Q491/3X50  
Q491/5X60  
Q491/6X60  
Ø 10 H 34 cm

**BAMBOO**  
Q492/3X93  
Q492/5X82  
Q492/6X82  
Ø 10 H 51 cm

**BAMBOO**  
Q493/3X130  
Q493/5X105  
Q493/6X105  
Ø 10 H 68 cm

**BAMBOO**  
Q494/3X175  
Q494/5X125  
Q494/6X125  
Ø 10 H 85 cm

nero opaco/matt black  
metallici/metals  
golden black

Cod. /3X Nero opaco  
Matt black

Cod. /5X Rame  
Copper

Bronzo  
Bronze

Metallic  
Metallic

Ruggine  
Rust

Cod. /6X Golden black

CERAMICHE - CERAMICS

MALAMOCCO collection

pag. 150 - 173

Vaso in ceramica finitura golden black.  
Ceramic vases in golden black finishing.

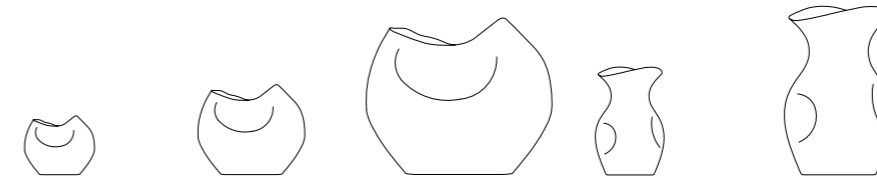

**MALAMOCCO**  
Q313/6X40  
Ø 26 H 21 cm

**MALAMOCCO**  
Q314/6X95  
Ø 40 H 30 cm

**MALAMOCCO**  
Q316/6X220  
Ø 70 H 58 cm

**MALAMOCCO**  
Q312/6X70  
Ø 37 H 21 cm

**MALAMOCCO**  
Q315/6X168  
Ø 40 H 63 cm

Cod. /6X Golden black

SFACE collection

pag. 61

Vaso in ceramica finitura golden black.  
Ceramic vases in golden black finishing.

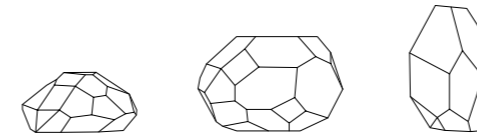

**SFACE**  
Q320/6X90  
L 40 P 36 H 40 cm

**SFACE**  
Q321/6X90  
L 50 P 25 H 33 cm

**SFACE**  
Q319/6X90  
Ø 30 H 44 cm

Cod. /6X Golden black

HIPPO collection

pag. 71 - 93 - 117 - 131 - 133 - 136

Hippo in ceramica in varie finiture.  
Ceramic Hippo in different finishings.

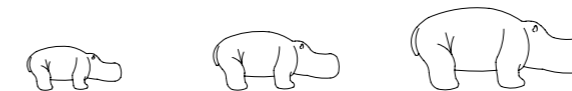

**HIPPO MINI**  
Q451X30  
Q451/1X30  
Q451/6X35  
Q451/MX40  
Q451/2X60  
L 10 P 23 H 12 cm

**HIPPO**  
Q439X50  
Q439/1X50  
Q439/6X60  
Q439/MX60  
Q439/2X75  
L 30 P 16 H 15 cm

**HIPPO BIG**  
Q440X180  
Q440/1X180  
Q440/6X180  
Q440/MX240  
Q440/2X350  
L 70 P 34 H 30 cm

smaltata/glazed  
RAL color  
golden black  
madreperla/mother of pearl  
platino, oro, oro rosa/platinum, gold, pink gold

Cod. X Bordeaux lucido  
Glazed bordeaux

Corallo lucido  
Glazed coral

Cod. /1X RAL opaco  
Matt RAL

Cod. /6X Golden black

Cod. /MX Turchese  
Turquoise

Madreperla  
Mother of pearl

Fuxia  
Fuchsia

Cod. /2X Platino lucido  
Glazed platinum

Oro lucido  
Glazed gold

Oro rosa lucido  
Glazed pink gold

HIPPO WAGON

pag. 35 - 53

Hippo Wagon ceramica in varie finiture.  
Ceramic Hippo Wagon in different finishings.

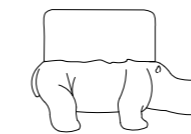

**HIPPO WAGON**  
Q452X300 bordeaux  
Q452/6X300 golden black  
Q452/2X380 platino, oro, oro rosa / platinum, gold, pink gold  
L 70 P 33 H 43 cm

**Base Hippo** Hippo base

Bianco lucido  
Glazed white

**Wagon Hippo**

Cod. X Bordeaux lucido  
Glazed bordeaux

Cod. /6X Golden black

Cod. /2X Platino lucido  
Glazed platinum

Oro lucido  
Glazed gold

Oro rosa lucido  
Glazed pink gold

CERAMICHE - CERAMICS

FABERGÈ collection

Ova in ceramica disponibili in varie finiture.  
Ceramic eggs available in various finishing.

pag. 165 - 178

Cod. /6X Golden black

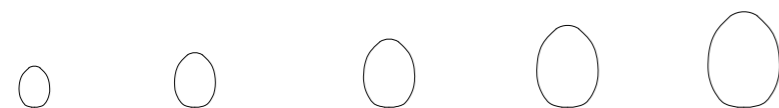

<b>OVO SMALL</b> Q123/6X16 Q123/2X34 Q123/8X36 Ø 10 H 15 cm	<b>OVO MEDIUM</b> Q124/6X19 Q124/2X46 Q124/8X50 Ø 15 H 20 cm	<b>OVO BIG</b> Q125/6X32 Q125/2X66 Q125/8X70 Ø 20 H 25 cm	<b>OVO 30</b> Q188/6X52 Q188/2X136 Q188/8X140 Ø 23 H 30 cm	<b>OVO 35</b> Q189/6X62 Q189/2X178 Q189/8X182 Ø 27 H 35 cm	golden black lucido/glazed oxyd
---	--	---	--	--	---------------------------------------

Cod. /2X Platino lucido  
Glazed platinum  
Oro lucido  
Glazed gold  
Oro rosa lucido  
Glazed pink gold

Cod. /8X Oxyd platino anticato  
Oxyd antique platinum  
Oxyd oro anticato  
Oxyd antique gold  
Oxyd oro rosa anticato  
Oxyd antique pink gold

FRUIT collection

Scultura di grandi dimensioni realizzata dal 1992 in ceramica finitura golden black.  
Great dimension sculpture realized since 1992 in ceramic golden black finishing.

pag. 179

Cod. /6X Golden black

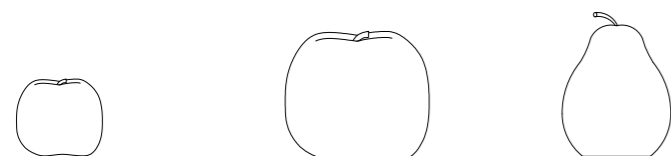

<b>MELA</b> Q417/6X40 Ø 28 H 28 cm	<b>MELA</b> 64T/6X126 Ø 48 H 43 cm	<b>PERA</b> 65T/6X126 Ø 40 H 48 cm
--	--	--

CHERRY FLOOR collection

Ciliegie da terra in ceramica golden black, bordeaux, platino, oro o oro rosa.  
Floor ceramic sculpture cherries golden black, bordeaux, platinum, gold or pink gold finishing.

pag. 28 - 72 - 120 - 178 - 180 - 205

Cod. X Bordeaux lucido  
Glazed bordeaux

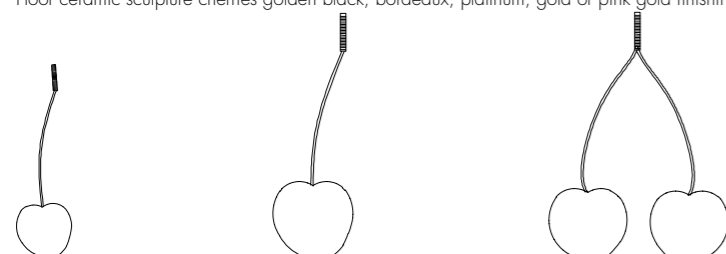

<b>CHERRY FLOOR SMALL</b> Q280X110 Q280/6X110 Q280/2X160 Ø 26 H 85 cm	<b>CHERRY FLOOR BIG</b> Q243X120 Q243/6X120 Q243/2X245 Ø 43 H 113 cm	<b>CHERRY FLOOR DOUBLE</b> Q244X190 Q244/6X190 Q244/2X440 Ø 43 L 90 H 113 cm	bordeaux golden black lucido/glazed
---	--	--	---

Cod. /6X Golden black

Cod. /2X Platino lucido  
Glazed platinum  
Oro lucido  
Glazed gold  
Oro rosa lucido  
Glazed pink gold

ZOE

Vaso in ceramica smaltata.  
Glazed ceramic vase.

pag. 104



Cod. /5X Rame  
Copper  
Bronzo  
Bronze  
Metallic  
Metallic  
Ruggine  
Rust  
Cod. /6X Golden black

Q126/5X125 metallic/metals  
Q126/6X125 golden black  
Ø 21 H 92 cm

CIGAR

Vaso in ceramica verniciata in varie finiture.  
Glazed ceramic vase in different finishings.

pag. 122



Cod. /5X Rame  
Copper  
Bronzo  
Bronze  
Metallic  
Metallic  
Ruggine  
Rust  
Cod. /6X Golden black

Q353/5X164 metallic/metals  
Q353/6X164 golden black  
Ø 25 H 110 cm

CERAMICHE - CERAMICS

MISTER BLUE collection

Vasi in ceramica finitura Mr. Blue, ruggine e bluette.  
Ceramic vases in Mr. Blue finishing, rust and blue.

pag. 141 - 143

Mr. Blue

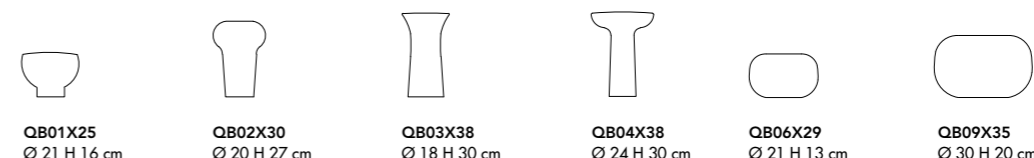

<b>QB01X25</b> Ø 21 H 16 cm	<b>QB02X30</b> Ø 20 H 27 cm	<b>QB03X38</b> Ø 18 H 30 cm	<b>QB04X38</b> Ø 24 H 30 cm	<b>QB06X29</b> Ø 21 H 13 cm	<b>QB09X35</b> Ø 30 H 20 cm
--------------------------------	--------------------------------	--------------------------------	--------------------------------	--------------------------------	--------------------------------

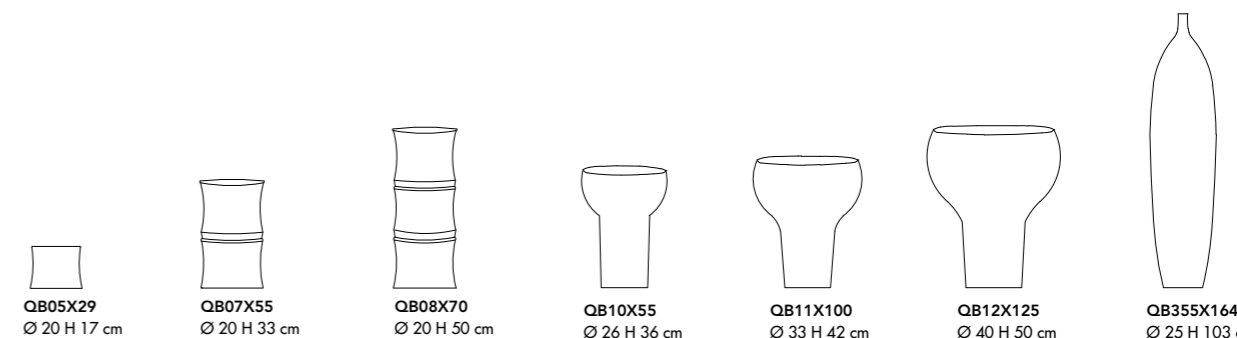

<b>QB05X29</b> Ø 20 H 17 cm	<b>QB07X55</b> Ø 20 H 33 cm	<b>QB08X70</b> Ø 20 H 50 cm	<b>QB10X55</b> Ø 26 H 36 cm	<b>QB11X100</b> Ø 33 H 42 cm	<b>QB12X125</b> Ø 40 H 50 cm	<b>QB355X164</b> Ø 25 H 103 cm
--------------------------------	--------------------------------	--------------------------------	--------------------------------	---------------------------------	---------------------------------	-----------------------------------

HABIBI, AMAL

Testa in ceramica in finitura esterna nero, bianco opaco o golden black con interno nero o bianco opaco.  
Ceramic head outside matt black, white or golden black inside matt black or white finishing.

pag. 27

Cod. /3X Nero opaco  
Matt black

Bianco opaco  
Matt white

Cod. /6X Golden black

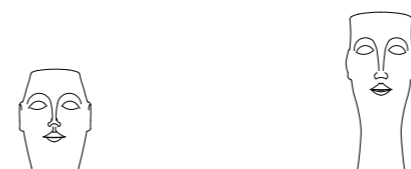

<b>HABIBI</b> Q404/3X82 opaco/matt Q404/6X102 golden black Ø 21 H 30 cm	<b>AMAL</b> Q405/3X82 opaco/matt Q405/6X102 golden black Ø 18 H 45 cm
--	--

BUONGIORNO, BUONASERA

Scultura in ceramica opaca.  
Matt ceramic sculpture.

pag. 109 - 126



<b>BUONGIORNO</b> Q454/1X70 opaco/matt Q454/5X80 metallic/metals Q454/6X80 golden black L 35 H 60 cm	<b>BUONASERA</b> Q455/1X70 opaco/matt Q455/5X80 metallic/metals Q455/6X80 golden black L 35 H 60 cm
--	---

Cod. /1X Blu opaco  
Matt blue

Fuxia opaco  
Matt fuchsia

Cod. /5X Rame  
Copper

Bronzo  
Bronze

Metallic  
Metallic

Ruggine  
Rust

Cod. /6X Golden black

CERAMICHE - CERAMICS

QUEEN e PRINCE

Rana in ceramica opaca bianca nelle finiture oxyd antico: platino o oro rosa.  
Ceramic frog matt white or oxyd antique finishing: platinum or pink gold.

pag. 51 - 99 - 132



**QUEEN**  
Rana  
bianco opaco.  
Matt white frog.

Q495/3X38  
L 15 P 13 H 12 cm



**QUEEN**  
Rana oxyd  
platino anticato.  
Oxyd antique  
platinum frog.

Q495/8X85  
L 15 P 13 H 15 cm

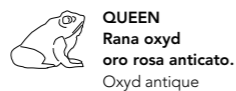

**QUEEN**  
Rana oxyd  
oro rosa anticato.  
Oxyd antique  
pink frog.

Q495/8X85  
L 15 P 13 H 15 cm



**PRINCE**  
Prince bianco opaco,  
corona platino.  
Matt white Prince,  
platinum crown.

Q496/3X55  
L 15 P 13 H 15 cm



**PRINCE**  
Prince oxyd platino  
anticato corona oro.  
Oxyd antique  
platinum Prince,  
platinum crown.

Q496/8X85  
L 15 P 13 H 15 cm

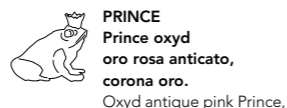

**PRINCE**  
Prince oxyd  
oro rosa anticato,  
corona oro.  
Oxyd antique pink Prince,  
gold crown.

Q496/8X85  
L 15 P 13 H 15 cm

Cod. /3X Bianco opaco  
Matt white



Cod. /8X Oxyd platino anticato  
Oxyd antique platinum



Oxyd oro rosa anticato  
Oxyd antique pink gold



CALL

Vaso in ceramica in varie finiture: bordeaux o giallo lucido, oxyd platino anticato o nero opaco.  
Ceramic vase in different finishings: bordeaux or yellow color, matt black or oxyd finishing in antique platinum.

pag. 69



**CALL**  
08TX25 lucido/glazed  
08T/3X25 nero opaco/matt black  
08T/8X54 oxyd  
Ø 14 H 22 cm

Cod. X Giallo lucido  
Glazed yellow



Bordeaux lucido  
Glazed bordeaux



Cod. /3X Nero opaco  
Matt black



Cod. /8X Oxyd platino anticato  
Oxyd antique platinum



TOB e CHIC LISCIO/SMOOTH

Vaso in ceramica in finitura liscia disponibile in vari colori.  
Ceramic vase in smooth finishing available in different colors.

pag. 69 - 94



**TOB SMALL**  
Q106X30  
Q106/3X30  
Q106/8X79  
Ø 25 H 25 cm



**TOB BIG**  
Q107X36  
Q107/3X36  
Q107/8X95  
Ø 30 H 30 cm



**CHIC SMALL**  
Q104X28  
Q104/3X28  
Q104/8X70  
Ø 20 H 25 cm



**CHIC BIG**  
Q105X38  
Q105/3X38  
Q105/8X89  
Ø 25 H 30 cm

lucido/glazed  
nero opaco/matt black  
oxyd

Cod. X Giallo lucido  
Glazed yellow



Bordeaux lucido  
Glazed bordeaux



Cod. /3X Nero opaco  
Matt black



Cod. /8X Oxyd platino anticato  
Oxyd antique platinum



TOB e CHIC RIGATO/RIDGED

Vaso in ceramica finitura rigata disponibile in vari colori.  
Ridged ceramic vase available in different finishing.

pag. 32 - 69 - 94

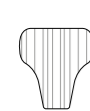

**TOB SMALL**  
Q106/5RX32  
Ø 25 H 25 cm

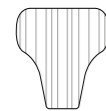

**TOB BIG**  
Q107/5RX42  
Ø 30 H 30 cm



**CHIC SMALL**  
Q104/5RX32  
Ø 20 H 25 cm



**CHIC BIG**  
Q105/5RX42  
Ø 25 H 30 cm

Cod. /5RX Ceramica rigata  
Ridged ceramic



Colori disponibili  
Available colors

Rame  
Copper



Bronzo  
Bronze



Metallic  
Metallic



Ruggine  
Rust



CERAMICHE - CERAMICS

ONION collection

Vaso in ceramica smaltata lucida platino e nero, platino e bianco o tutto platino.  
Glazed ceramic vase black and platinum, white and platinum or all platinum.

pag. 92 - 184



**ONION**  
bianco/white  
Q233X125  
Ø 30 H 35 cm



**ONION**  
nero/black  
Q233X125  
Ø 30 H 35 cm



**ONION**  
platino/platinum  
Q233/2X159  
Ø 30 H 35 cm

Cod. X Nero lucido + platino  
Glazed black + platinum



Bianco lucido + platino  
Glazed white + platinum



Cod. /2X Platino lucido  
Glazed platinum



ONDA

Vaso onda in ceramica opaca finitura metallo o in ceramica smaltata placcata oro, platino e oro rosa.  
Onda vase in glazed ceramic pleated gold, platinum, pink gold and matt metallic.

pag. 45 - 75



**ONDA**  
Q193/3X90 nero opaco/matt black  
Q193/2X299 platino, oro, oro rosa/platinum, gold, pink gold  
L 50 P 35 H 25 cm

Cod. /3X Nero opaco  
Matt black



Cod. /2X Platino lucido  
Glazed platinum



Oro lucido  
Glazed gold



Oro rosa lucido  
Glazed pink gold



CANALETTO

Vaso in ceramica in varie finiture.  
Ceramic vase in different finishings.

pag. 50



**CANALETTO**  
Q296X46 lucido/glazed  
Q296/3X46 nero opaco/matt black  
Q296/8X70 oxyd  
Q296/2X70 platino, oro, oro rosa/platinum, gold, pink gold  
Ø 10 H 61 cm

Cod. X Giallo lucido  
Glazed yellow



Bordeaux lucido  
Glazed bordeaux



Cod. /3X Nero opaco  
Matt black



Cod. /8X Oxyd platino anticato  
Oxyd antique platinum



Oxyd oro anticato  
Oxyd antique gold



Oxyd rosa anticato  
Oxyd antique pink



Cod. /2X Platino lucido  
Glazed platinum



Oro lucido  
Glazed gold



Oxyd oro rosa anticato  
Oxyd antique pink gold



SFERA

Vaso sfera in ceramica in finitura oxyd platino anticato.  
Glazed ceramic sphere oxyd finishing in antique platinum.

Cod. /3X Nero opaco  
Matt black



Cod. /8X Oxyd platino anticato  
Oxyd antique platinum



**SFERA**  
15T/3X14 nero opaco/black matt  
15T/8X45 oxyd  
Ø 15 H 10 cm



**SFERA**  
14T/3X18 nero opaco/black matt  
14T/8X48 oxyd  
Ø 20 H 12 cm



**SFERA**  
13T/3X20 nero opaco/black matt  
13T/8X52 oxyd  
Ø 29 H 14 cm

VETRI - GLASSES

**ABSOLUTE**

Vasi in vetro colorato.  
Colored glass vases.

pag. 76 - 129

Fumè  
Smoked grey



Blu  
Blue



Ametista  
Amethyst

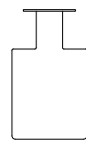

**ABSOLUTE**  
Fumè / Smoked grey  
C200AX40  
Ø 26 H 40 cm

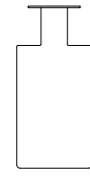

**ABSOLUTE**  
Blu/Blue  
C200BX44  
Ø 23 H 50 cm



**ABSOLUTE**  
Ametista/Amethyst  
C200CX48  
Ø 19,5 H 60 cm

**ELITE**

Vasi in vetro colorato.  
Colored glass vases.

pag. 128 - 137

Fumè  
Smoked grey



Blu  
Blue

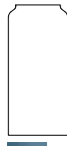

**ELITE**  
Blu/Blue  
C202AX30  
Ø 19 H 40 cm



**ELITE**  
Fumè/Smoked grey  
C202BX40  
Ø 19 H 60 cm

**ELOYSE**

Vasi in vetro fumè cannettato.  
Smoked ridged grey glass vases.

pag. 89

Fumè  
Smoked grey

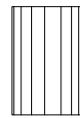

**ELOYSE**  
C207AX34  
Ø 20 H 30 cm

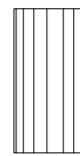

**ELOYSE**  
C207BX46  
Ø 20 H 40 cm

**PONGO**

Vaso in vetro di Murano grigio fumè.  
Smoked grey Murano glass vase.

pag. 9 - 30 - 86 - 138

Fumè  
Smoked grey



**PONGO**  
C178X100  
Ø 12 H 35 cm



**PONGO**  
C179X150  
Ø 20 H 40 cm

VETRI - GLASSES

**GONG**

Vaso in vetro fumè con base in metallo antracite.  
Smoked grey glass vase with metal anthracite base.

pag. 88

Fumè  
Smoked grey



Base metallo  
Metal base

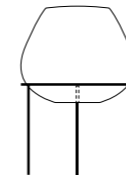

**GONG**  
C208X80  
Ø 44 H 35 cm vaso/vase  
H25 cm struttura/structure

**GUEST**

Vaso in vetro sfumato fumè riflettente.  
Vase in shaded reflective glass.

pag. 70 - 118 - 121 - 195

Vetro trasparente  
Transparent glass



**GUEST**  
C203X39  
Ø 24 H 30 cm

**TORCH**

Vaso in vetro trasparente.  
Transparent glass vase.

pag. 87

Vaso trasparente  
Transparent vase



**TORCH**  
C132AX32  
Ø 24 H 50 cm

**POLINE**

Vaso in vetro trasparente con decoro lineare inciso effetto cristallo.  
Transparent glass vase with decor crystal effect.

pag. 209

Vaso trasparente  
Transparent vase

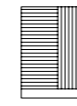

**POLINE**  
C201AX40  
Ø 18 H 25 cm

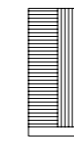

**POLINE**  
C201BX35  
Ø 15 H 35 cm

VETRI - GLASSES

**SETUS SQUARE**

Vaso in vetro di Murano tortora con base in vetro quadrata ambra.  
Murano glass vase dove color with glass square-shaped base finishing.

pag. 189 - 200

Vaso vetro tortora  
Dove color glass vase



Base vetro ambra  
Glass amber base

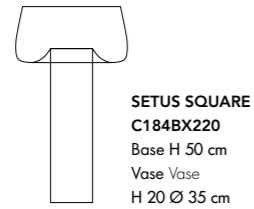
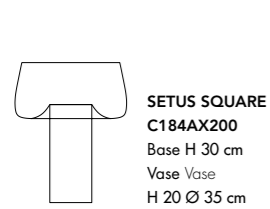

**SETUS SQUARE HIGH**

Vaso in vetro di Murano tortora con base quadrata in legno verniciato golden black.  
Murano glass vase dove color with lacquered wood square-shaped base golden black.

pag. 44

Vaso vetro tortora  
Dove color glass vase



Base legno verniciato  
golden black  
Base lacquered wood  
golden black

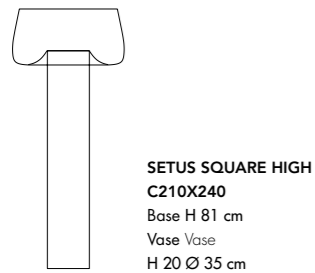

**MITO CROSS**

Vaso in vetro di Murano trasparente con base in vetro a croce fumè.  
Murano glass transparent vase with glass cross shape base finishing smoky grey.

pag. 42 - 171 - 200

Vaso vetro trasparente  
Glass transparent vase



Base vetro fumè  
Smoke grey glass base

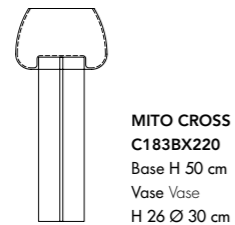
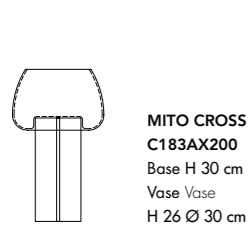

**MITO CROSS HIGH**

Vaso in vetro di Murano trasparente con base a croce in legno verniciato golden black.  
Murano glass transparent vase with wood cross shape base finishing golden black.

pag. 44

Vaso vetro trasparente  
Glass transparent vase



Base legno verniciato  
golden black  
Base lacquered wood  
golden black

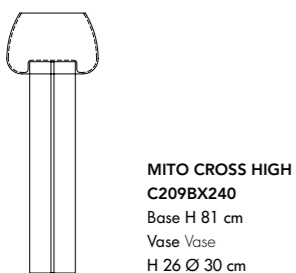

VETRI - GLASSES

**LORD**

Vaso in vetro di Murano in finitura tortora o rosa sfumato.  
Vase in Murano glass finishing dove color or shaded pink.

pag. 78 - 168

Vetro tortora  
Dove color vase



Vetro rosa sfumato  
Glass shaded pink

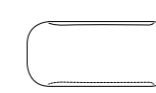

**BOUBLE**

Vaso in vetro di Murano grigio fumè o acquamarina con struttura in metallo.  
Vase in smoked grey Murano glass or aquamarine with metal structure.

pag. 34 - 142 - 206 - 219 - 232

Vetro acquamarina  
Acquamarine glass



Vetro fumè  
Smoked grey glass



Base metallo inox  
Steel metal base

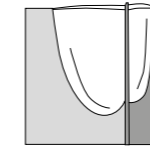
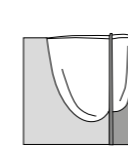

**PERA e FAGIOLO OVALE GIGANTE**

Vaso in vetro soffiato trasparente - Art. Brevettato.  
Transparent blown glass vase - Patented item.

pag. 51 - 59

Vetro trasparente  
Transparent glass



**TECA**

Teca portaoggetti in vetro trasparente spessore 3 mm con bordo in ottone nero spessore 4 mm.  
Storage case in transparent glass thickness 3 mm with edge in black brass thickness 4 mm.

pag. 38 - 194 - 235

Vetro trasparente  
Transparent glass



Base antracite  
Anthracite base



WALL ART



HARMONY collection

pag. 47 - 103

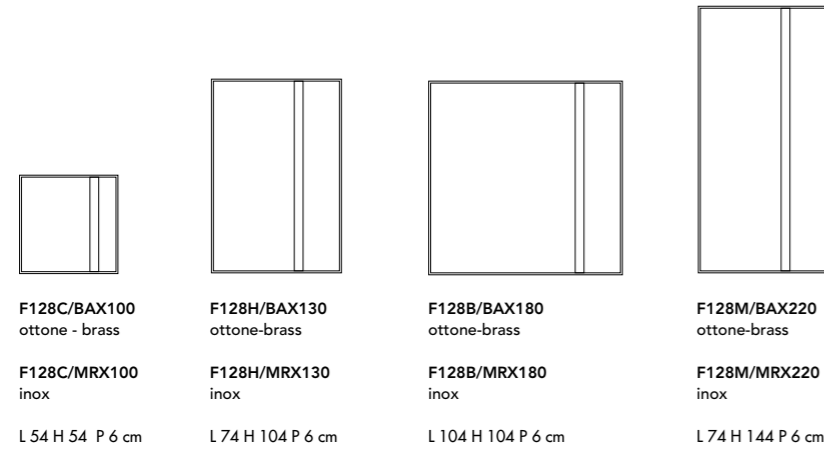
Quadro materico con finitura cementizia e fascia decorativa larghezza 4 cm in acciaio inox o ottone.  
Cornice moma spessore 6 cm in finitura laccata opaca nera per profilo inox e golden black per profilo ottone.  
Materic painting concrete effect decorative stripes width 4 cm in inox or brass.  
Moma frame thickness 6 cm lacquered matt finishing balck for inox stripe or golden black for brass stripes.



<b>F128C/BAX100</b> ottone - brass	<b>F128H/BAX130</b> ottone-brass	<b>F128B/BAX180</b> ottone-brass	<b>F128M/BAX220</b> ottone-brass
<b>F128C/MRX100</b> inox	<b>F128H/MRX130</b> inox	<b>F128B/MRX180</b> inox	<b>F128M/MRX220</b> inox
L 54 H 54 P 6 cm	L 74 H 104 P 6 cm	L 104 H 104 P 6 cm	L 74 H 144 P 6 cm

Cod. **/BA**  
CORNICE /FRAME FASCIA /STRIPE  
Golden black  



Fascia ottone / Brass stripe

Cod. **/MR**  
CORNICE /FRAME PROFILO /PROFILE  
Nero opaco  



Fascia inox / Inox stripe

HARMONY

Soggetti disponibili.  
Available subject.

Formato quadrato.  
Square size.



<b>2285</b> Fascia inox / Inox stripe	<b>2287</b> Fascia inox / Inox stripe	<b>2286</b> Fascia ottone / Brass stripe
--	--	---

Formato rettangolare.  
Rectangular size.

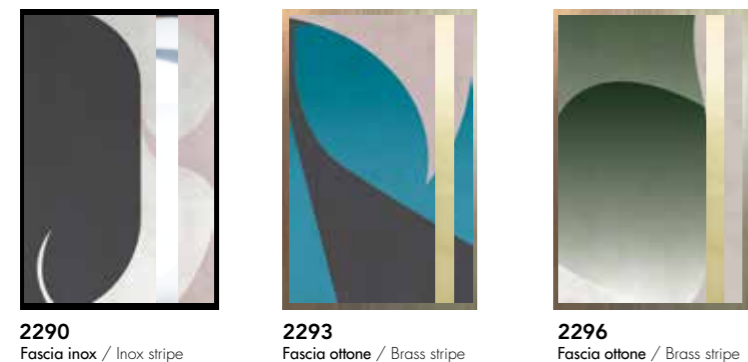

<b>2290</b> Fascia inox / Inox stripe	<b>2293</b> Fascia ottone / Brass stripe	<b>2296</b> Fascia ottone / Brass stripe
--	---	---



OYSTER collection

pag. 43 - 47 - 103 - 161

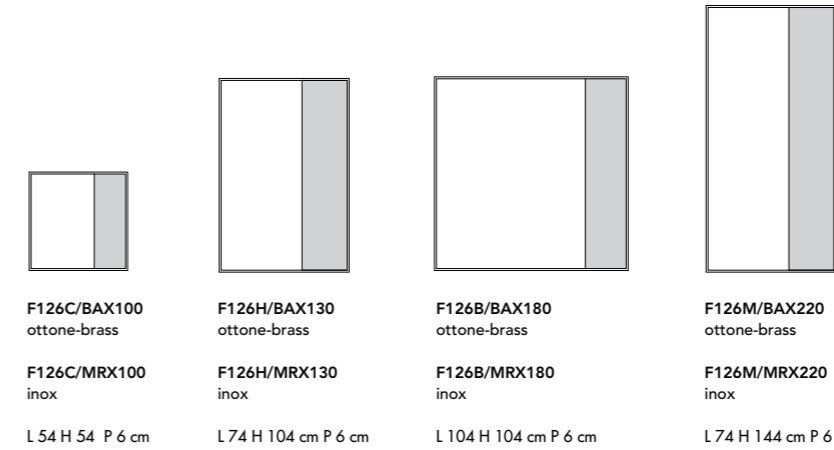
Quadro materico con finitura cementizia e profilo decorativo spess. 1 cm in acciaio inox o ottone.  
Cornice Moma spessore 6 cm in finitura laccata nera opaca per profilo inox e golden black per profilo ottone.  
Materic painting concrete effect decorative profile thickness 1 cm in inox or brass.  
Moma frame thickness 6 cm lacquered matt finishing balck for inox profile and golden black for brass profile.





<b>F126C/BAX100</b> ottone-brass	<b>F126H/BAX130</b> ottone-brass	<b>F126B/BAX180</b> ottone-brass	<b>F126M/BAX220</b> ottone-brass
<b>F126C/MRX100</b> inox	<b>F126H/MRX130</b> inox	<b>F126B/MRX180</b> inox	<b>F126M/MRX220</b> inox
L 54 H 54 P 6 cm	L 74 H 104 cm P 6 cm	L 104 H 104 cm P 6 cm	L 74 H 144 cm P 6 cm

Cod. **/BA**  
CORNICE /FRAME PROFILO /PROFILE  
Golden black  



Profilo ottone / Brass profile

Cod. **/MR**  
CORNICE /FRAME PROFILO /PROFILE  
Nero opaco  



Profilo inox / Inox profile

OYSTER

Soggetti disponibili.  
Available subject.

Formato quadrato.  
Square size.

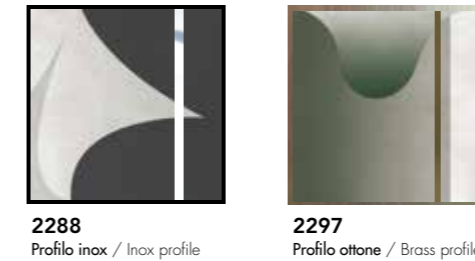

<b>2288</b> Profilo inox / Inox profile	<b>2297</b> Profilo ottone / Brass profile
--	---

Formato rettangolare.  
Rectangular size.

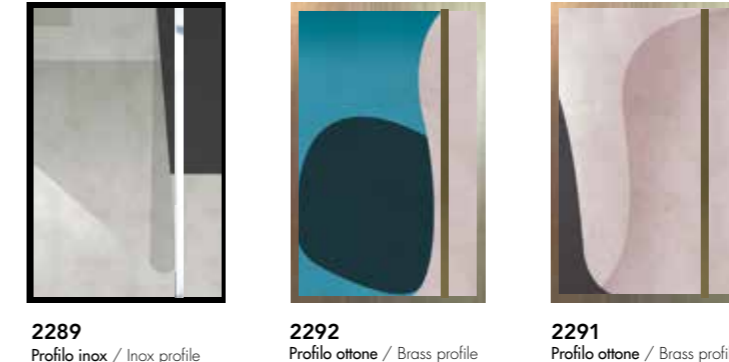

<b>2289</b> Profilo inox / Inox profile	<b>2292</b> Profilo ottone / Brass profile	<b>2291</b> Profilo ottone / Brass profile
--	---	---



WALL ART

GIOTTO collection

Quadro rotondo con stampa digitale tessuto poliuretano opaco, spessore 4 cm. A richiesta stampa personalizzata.  
Round painting with digital printing polyurethane matt tissue, thickness 4cm. Upon request with customized graphic.

pag. 186

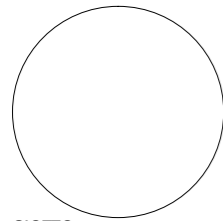

GIOTTO  
F156X160  
Ø 120 cm

Soggetti Subjects



0112



0126



0121



0128



2298



2299



2300



0111



0021

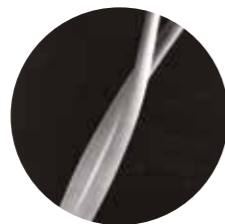

0026



0552



0555



0554

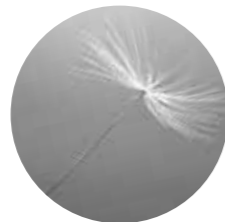

0414



0440



2301

A RICHIESTA STAMPA PERSONALIZZATA. UPON REQUEST WITH A CUSTOMIZED GRAPHIC.

ELLIS collection

Quadro ellittico con stampa digitale in tessuto poliuretano opaco, spessore 4 cm. A richiesta stampa personalizzata.  
Elliptical painting with digital printing polyurethane matt tissue, thickness 4cm. Upon request with customized graphic.

pag. 53

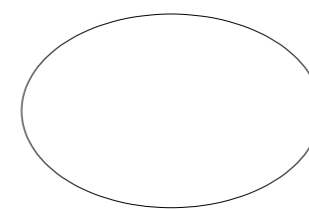

ELLIS  
F157X180  
L 160 H 100 cm

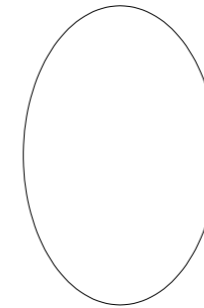

ELLIS  
F157X180  
L 100 H 160 cm

Soggetti Subjects



0112



0126



0121



0128



2298



2299



2300



0111



0021



0026



0552



0555



0554

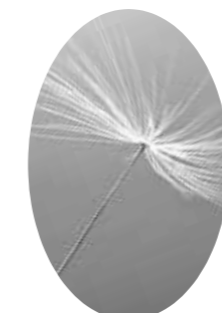

0414



0440

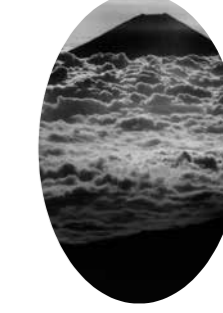

2301

A RICHIESTA STAMPA PERSONALIZZATA. UPON REQUEST WITH A CUSTOMIZED GRAPHIC.

WALL ART

MISS MARY collection

Quadri artistici in legno scolpiti manualmente. Cornice Moma in finitura golden black.  
Artistic paintings handmade engraved wood. Moma frame in golden black finishing.

Spessore Thickness 6 cm

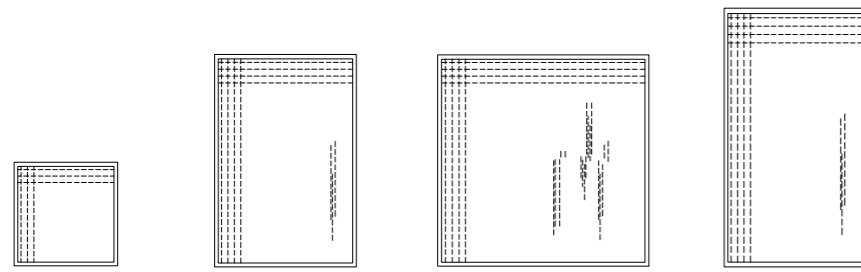

MISS MARY F135CX100 54 x 54 cm  
MISS MARY F135HX130 74 x 104 cm  
MISS MARY F135BX180 104 x 104 cm  
MISS MARY F135MX220 74 x 144 cm  
MISS MARY F135KX120 29 x 184 cm

pag. 215

Golden black



MISS ITALIA collection

Quadri in MDF scolpiti manualmente con cornice sp. 6 cm laccati lucidi con sfumature.  
Painting in MDF handmade carved with frame thk. 6cm lacquered shiny with shades.

Spessore Thickness 6 cm

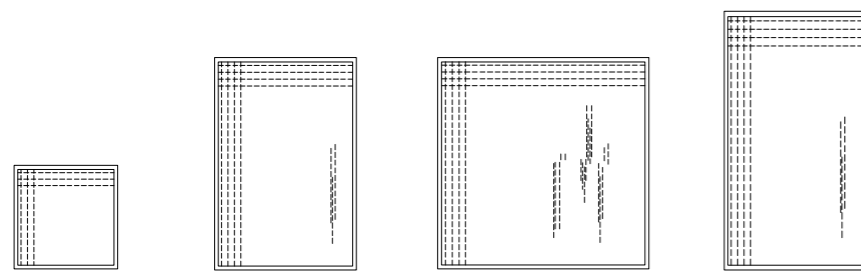

MISS ITALIA F145CX100 54 x 54 cm  
MISS ITALIA F145HX130 74 x 104 cm  
MISS ITALIA F145BX180 104 x 104 cm  
MISS ITALIA F145MX220 74 x 144 cm  
MISS ITALIA F145KX120 29 x 184 cm

pag. 145

Finiture laccate lucide.  
Glossy lacquered finishes.

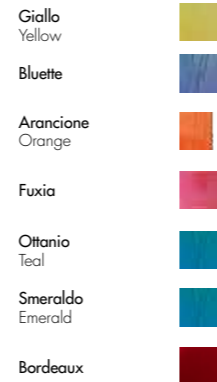

OCEANO collection

Quadri artistici in stucco e resina eseguito manualmente. Cornice Moma in finitura golden black.  
Artistic paintings made with stucco and resin manually executed. Moma frame in golden black finishing.

pag. 163

M6  
Blu Oceano  
Ocean blue

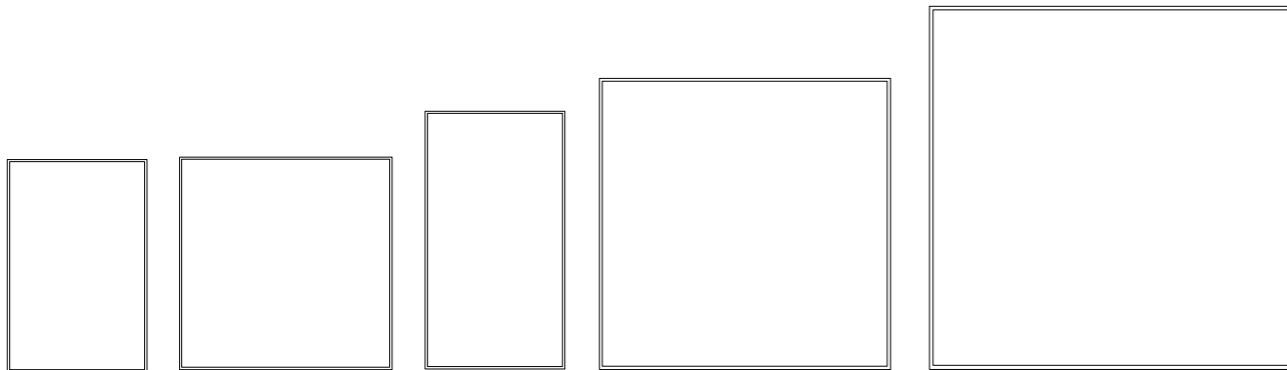
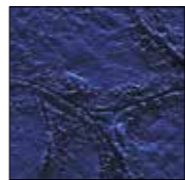

OCEANO F136HX260 74 x 104 cm  
OCEANO F136BX300 104 x 104 cm  
OCEANO F136MX440 74 x 144 cm  
OCEANO F136TX900 154 x 154 cm  
OCEANO F136UX1200 184 x 184 cm

A RICHIESTA COLORI PERSONALIZZATI. UPON REQUEST WITH CUSTOMIZED COLORS.

WALL ART

MURALES collection

pag. 35 - 157 - 212 - 232

Quadri materici stampati su superficie cementizia eseguiti a mano. Cornice Moma in finitura nera opaca, golden black, oro e rame.  
Materic printed paintings on concrete surface handmade. Moma frame golden black, gold or copper finishing.

Cornice laccata spessore 6 cm  
Lacquered frame thickness 6 cm

Scegli i soggetti dai nostri quadri, carte da parati o tappeti (cataloghi o sito web).  
Choose the subjects from our paintings, wallpapers or rugs (catalogues or web site).

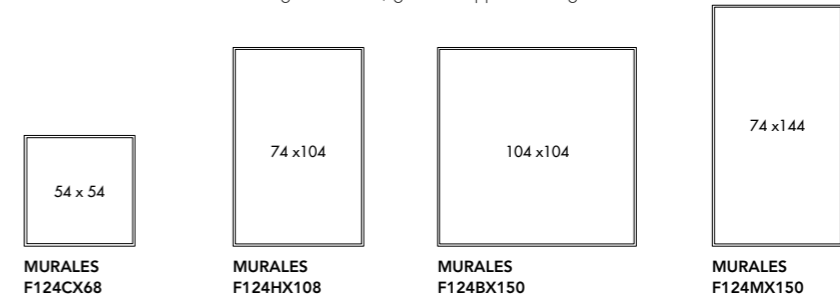

MURALES F124CX68  
MURALES F124HX108  
MURALES F124BX150  
MURALES F124MX150

Alcuni esempi a pagina:  
Some examples on page:  
254 - 255 - 257 - 259 - 262 - 263 - 265

FOUR SEASON collection

pag. 105 - 170 - 221

Set di 2 quadri materici stampati su superficie cementizia eseguiti a mano. Cornice Moma in finitura nera opaca, golden black, oro e rame.  
Il soggetto del quadro è sempre diviso in 2 parti.  
Set of two materic printed paintings on concrete surface handmade. Moma frame golden black, gold or copper finishing.  
The graphic is always divided in two parts.

Spessore Thickness 6 cm



FOUR SEASON F137CX200

FOUR SEASON F137HX390

FOUR SEASON F137BX480

Cornice laccata / Lacquered frame

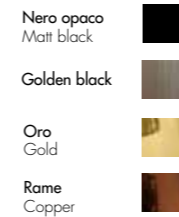

FOUR SEASON collection  
Soggetti Subjects



KA1818

FS2104

FS2105

FS2102

FS1817

FS2103

FS2106

WALL ART

MUSEUM collection

Quadro artistico in metallo in finitura golden black, nicchia realizzata a mano da nostri maestri artigiani con diverse tecniche.  
Artistic metallic painting finishing golden black, recess handmade by our master artisan with different techniques.

pag. 40 - 106

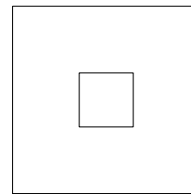

F138BX190  
100 x 100 cm sp. / th. 1 cm  
Nicchia / Niche 25x25

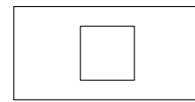

F138AX160  
100 x 50 cm sp. / th. 1 cm  
Nicchia / Niche 25x25

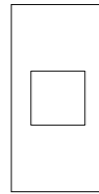

F138AX160  
50 x 100 cm sp. / th. 1 cm  
Nicchia / Niche 25x25



Vedi decori pagina a fianco.

See decorations on the opposite page.

STONE ART collection

Sassi in ceramica decorata a mano dai nostri maestri artigiani con particolare in foglia oro o argento.  
Ceramic stones handmade decorated by our master artisan with golden leaf or silver detail.

pag. 85



ALC027/ARTX65  
22 x 27 cm  
sp. / th. 6 cm



ALC028/ARTX79  
33 x 27 cm  
sp. / th. 6 cm



ALC029/ARTX119  
40 x 32 cm  
sp. / th. 6 cm



ALC030/ARTX129  
45 x 35 cm  
sp. / th. 8 cm

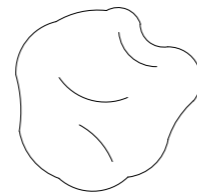

ALC044/ARTX260  
80 x 80 cm  
sp. / th. 10 cm

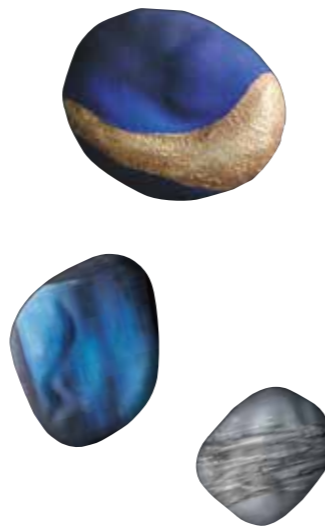

Vedi decori pagina a fianco.

See decorations on the opposite page.

Vedi altre finiture disponibili a pag 261.

See other finishes available on page 261.



Il Kit Luce può essere montato su tutti i sassi e in tutte le finiture.  
Il codice del Kit Luce va aggiunto al codice del sasso in ceramica.  
The light kit can be mounted on all the stones and in all finishes.  
The code of the light kit must be added to the code of the ceramic stone.

Kit Luce / Light Kit ALCEX35 1xE14 28 Watt



001M

002M

003M

006M

007M



013M



011M



012M



008M



014M

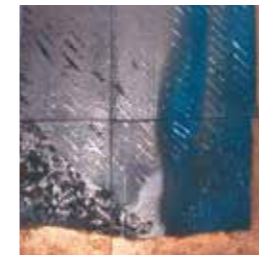

019M



020M



026M

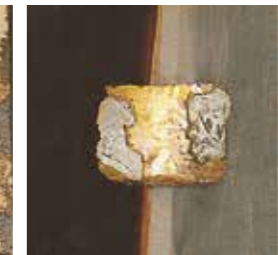

024M



025M



004M



009M



010M



015M



023M



016M



017M

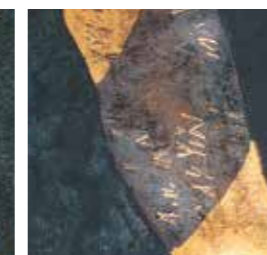

018M



021M



022M



027M

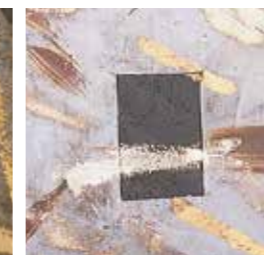

028M



029M



030M

WALL ART

VIP MIRROR collection

Specchiera con cornice in legno verniciato nero opaco e specchio fumè bordo filo lucido spessore 5 mm.  
Mirror with matt black wood frame and fumè mirror shiny edge thick 5 mm.

pag. 21

Cod. /X Nero lucido  
Glazed black

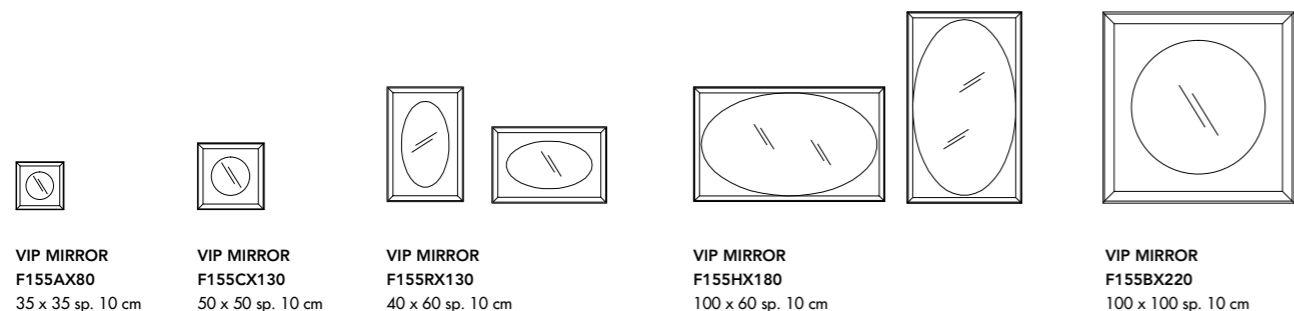

**VIP MIRROR F155AX80** 35 x 35 sp. 10 cm  
**VIP MIRROR F155CX130** 50 x 50 sp. 10 cm  
**VIP MIRROR F155RX130** 40 x 60 sp. 10 cm  
**VIP MIRROR F155HX180** 100 x 60 sp. 10 cm  
**VIP MIRROR F155BX220** 100 x 100 sp. 10 cm

PLANETA collection

Specchiera luminosa in metallo verniciato golden black, specchio fumè spessore 5 mm con bordo a filo lucido.  
Luminous mirror metallic varnish golden black fumè mirror thnk 5mm shiny edge.

pag. 21 - 23 - 193

Cod. /X Nero lucido  
Glazed black

Luce LED 12V 25W  
LED light

Da tavolo Table

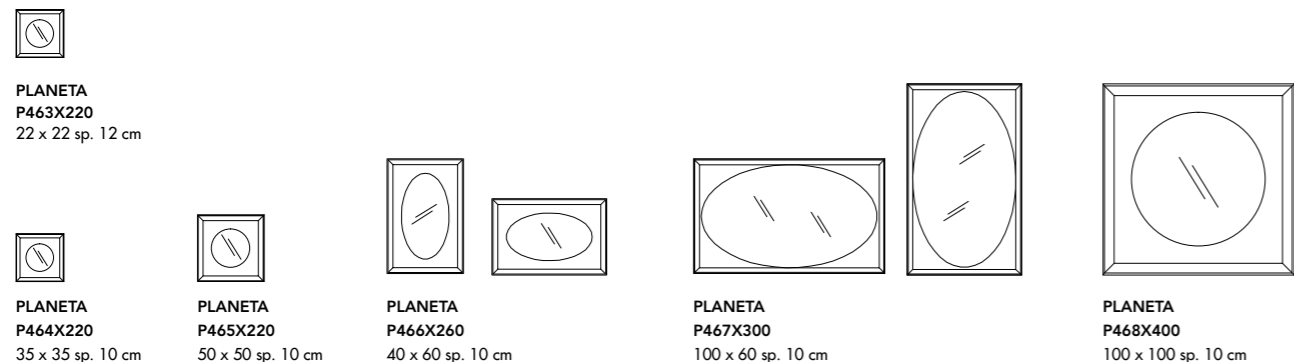

**PLANETA P463X220** 22 x 22 sp. 12 cm  
**PLANETA P464X220** 35 x 35 sp. 10 cm  
**PLANETA P465X220** 50 x 50 sp. 10 cm  
**PLANETA P466X260** 40 x 60 sp. 10 cm  
**PLANETA P467X300** 100 x 60 sp. 10 cm  
**PLANETA P468X400** 100 x 100 sp. 10 cm

AMADEUS collection

Scultura a muro in MDF verniciato metallico golden black.  
Golden black metallic painted MDF wall sculpture.

pag. 39 - 60 - 208

Cod. /6X Golden black

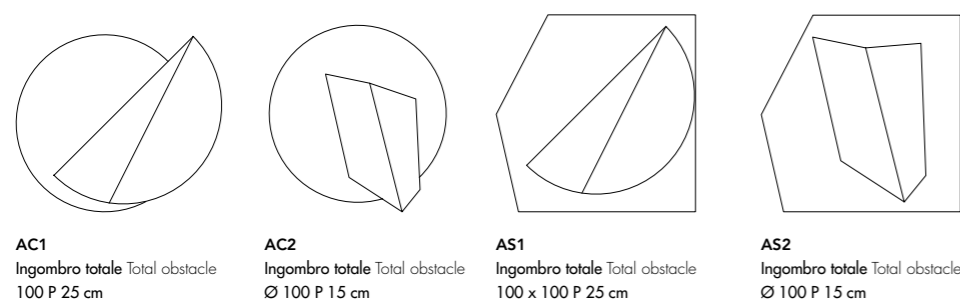

**AC1** Ingombro totale Total obstacle 100 P 25 cm  
**AC2** Ingombro totale Total obstacle Ø 100 P 15 cm  
**AS1** Ingombro totale Total obstacle 100 x 100 P 25 cm  
**AS2** Ingombro totale Total obstacle Ø 100 P 15 cm

AMADEUS  
F159/6X260

AMADEUS LIGHT F151/6X360 Luce LED 12V 25W LED light

WALL ART

CHERRY WALL collection

Ciliegie a muro in ceramica.  
Ceramic cherries for wall.

pag. 152

Cod. /X Bordeaux lucido  
Glazed black

Cod. /2X Platino lucido  
Glazed platinum

Oro lucido  
Glazed gold

Oro rosa lucido  
Glazed pink gold

Cod. /6X Golden black

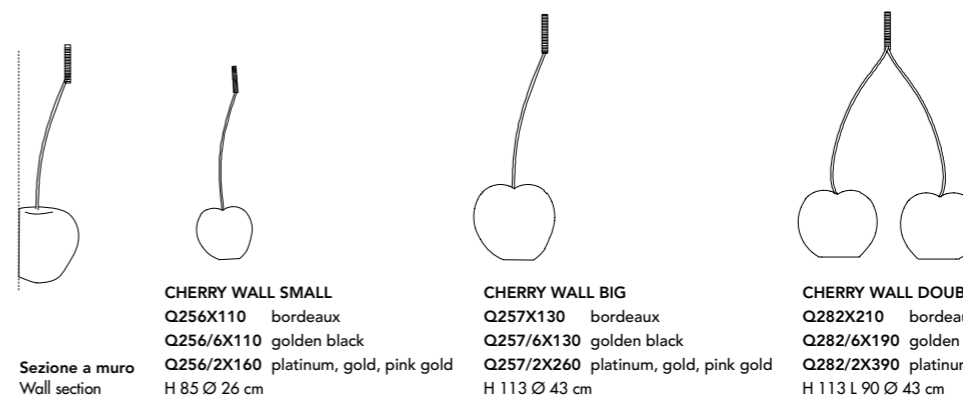

**CHERRY WALL SMALL** Q256X110 bordeaux  
Q256/6X110 golden black  
Q256/2X160 platinum, gold, pink gold  
H 85 Ø 26 cm  
**CHERRY WALL BIG** Q257X130 bordeaux  
Q257/6X130 golden black  
Q257/2X260 platinum, gold, pink gold  
H 113 Ø 43 cm  
**CHERRY WALL DOUBLE** Q282X210 bordeaux  
Q282/6X190 golden black  
Q282/2X390 platinum, gold, pink gold  
H 113 L 90 Ø 43 cm

STONE collection

Sassi a muro in ceramica. Disponibile versione con kit luce.  
Ceramic wall stone. Available with light kit version.

pag. 76 - 83 - 227

Cod. /1X RAL opaco  
Matt RAL

Cod. /2X Platino lucido  
Glazed platinum

Oro lucido  
Glazed gold

Oro rosa lucido  
Glazed pink gold

Cod. /6X Golden black

Cod. /8X Oxyd platino anticato  
Oxyd antique platinum



**ALC027/1X22** 22 x 27 cm  
**ALC027/6X30**  
**ALC027/2X65**  
**ALC027/8X65**  
**ALC028/1X26** 33 x 27 cm  
**ALC028/6X35**  
**ALC028/2X79**  
**ALC028/8X79**  
**ALC029/1X32** 40 x 32 cm  
**ALC029/6X40**  
**ALC029/2X119**  
**ALC029/8X119**  
**ALC030/1X39** 45 x 35 cm  
**ALC030/6X50**  
**ALC030/2X129**  
**ALC030/8X129**  
**ALC044/1X85** 80 x 80 cm  
**ALC044/6X120**  
**ALC044/2X260**  
**ALC044/8X260**

Il Kit luce può essere montato su tutti i sassi e in tutte le finiture.  
Il codice del Kit luce va aggiunto al codice del sasso in ceramica.  
The light kit can be mounted on all the stones and in all finishes.  
The code of the light kit must be added to the code of the ceramic stone.

Kit Luce / Light Kit ALCEX35 1xE14 28 Watt

QUINTA Separè

pag. 54 - 101 - 120 - 122 - 168

Separè a due o più ante con struttura in legno rivestita con tela stampata poliuretanicca opaca. Cerniere in tutta altezza in metallo inox completamente richiudibile su se stesso.  
Separè booth with two or more doors wood structure covered with printed polyurethane matt tissue. Inox joint that allows to close it completely.

QUINTA SOUND Separè

Separè a due o più ante con struttura in legno rivestita in pura lana vergine certificata ignifuga e soundproof. Cerniere in tutta altezza in metallo inox completamente richiudibile su se stesso.  
Separè booth with two or more doors wood structure covered with virgin wool certified fireproof and soundproof. Inox joint that allows to close it completely.

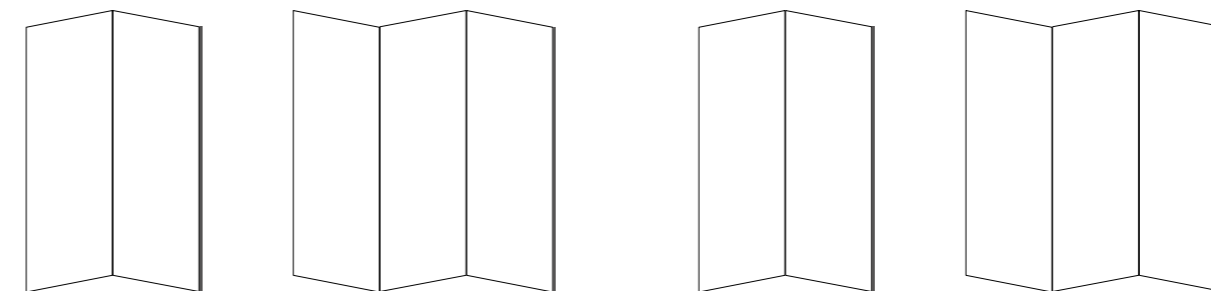

**QUINTA F158X300** L 140 (70+70) H 198 cm  
**QUINTA F159X450** L 210 (70+70+70) H 198 cm  
**QUINTA SOUND F160X350** L 128 (64+64) H 198 cm  
**QUINTA SOUND F161X480** L 192 (64+64+64) H 198 cm

Decorazioni in Total Look dal catalogo Wallpaper Adriani e Rossi, dai nostri quadri o da pag 254 - 255 - 262 - 263 - 265.  
Decorations in Total Look from the Adriani e Rossi Wallpaper catalog, from our paintings or from pages 254 - 255 - 262 - 263 - 265.

TAPPETI - RUGS

**PERSIA**

Tappeto in ciniglia tessuto in Europa con disegno rasato e filati lucidi a sbalzo con frangia.  
Chenille rug weaved in Europe with trimmed design and shiny embossed yarn with fringe.

pag. 97



**PERSIA**  
S129X400 200 x 290 cm

\* A RICHIESTA MISURE PERSONALIZZATE. UPON REQUEST WITH A CUSTOMIZED SIZES.

**BOSS**

Tappeto in cotone e viscosa a sbalzo tessuto a mano. Disponibile nei colori perla o grigio.  
Handwoven embossed rug, cotton and viscose. Available in pearl or grey color.

pag. 12



Perla / Pearl



Grigio / Grey

**BOSS**  
S136X290 160 x 240 cm  
S137X450 200 x 300 cm

\* A RICHIESTA MISURE PERSONALIZZATE. UPON REQUEST WITH A CUSTOMIZED SIZES.

**SUPERDIGIT**

Tappeto composizione filato 75% poliestere 25% cotone, tessitura Jacquard strutturata.  
Rug composition 75% polyester 25% cotton, structured Jacquard weaving.

pag. AMOUR 43 - 63 / MERAV 125 / GINZA 104 - 156



**AMOUR**  
SUPERDIGIT  
S155X300 200 x 300 cm  
S163X460 240 x 360 cm



MERAV



GINZA

TAPPETI - RUGS

**LAND**

Tappeto tessuto in viscosa Tencel.  
Viscose Tencel rug.

pag. 97



Tortora / Dove - color



Perla / Pearl



Grigio / Grey

**LAND**  
S139X390 200 x 300 cm

\* A RICHIESTA MISURE PERSONALIZZATE. UPON REQUEST WITH A CUSTOMIZED SIZES.

**LINE**

Tappeto in lana e viscosa.  
Wool and viscose rug.



Cammello / Camel



Grigio / Grey

**LINE**  
S28X320 200 x 300 cm

\* A RICHIESTA MISURE PERSONALIZZATE. UPON REQUEST WITH A CUSTOMIZED SIZES.

**KLEE CHENILLE**

Tappeto in ciniglia.  
Chenille rug.



**KLEE CHENILLE**  
S153X320 200 x 300 cm  
S165X480 240 x 360 cm

**KLEE**

Tappeto tessuto in viscosa Tencel.  
Viscose Tencel rug.



**KLEE**  
S161X660 200 x 300 cm  
S166X960 240 x 360 cm

\* A RICHIESTA MISURE PERSONALIZZATE. UPON REQUEST WITH A CUSTOMIZED SIZES.

pag. 37 - 135

TAPPETI - RUGS

ORMUS

Tappeto tessuto hand-loom, 100% in seta di bamboo.  
Hand-loom rug, 100% silk bamboo.

pag. 77



Cipria / Powder



Acquamarina / Aquamarine



Grigio scuro / Dark grey



Grigio chiaro / Light grey

ORMUS  
S159X660 200 x 300 cm

\* A RICHIESTA MISURE PERSONALIZZATE. UPON REQUEST WITH A CUSTOMIZED SIZES.

LOVAC

Tappeto ovale in poliammide filato soft nylon con stampa digitale nelle due colorazioni sfumate verde o grigio. Bordo a scomparsa in feltro. Forma organica.  
Oval shape rug polyamide soft nylon with digital printing in two colors shades green or grey. Organic shape.

pag. 11 - 13 - 221



Verde / Green



Grigio / Grey

LOVAC  
S162X800 198 x 320 cm

\* A RICHIESTA MISURE PERSONALIZZATE. UPON REQUEST WITH A CUSTOMIZED SIZES.

RIFLESSI

pag. 54 - 186

Tappeto in poliammide filato soft nylon lucente con stampa digitale disponibile in diverse grafiche. Bordo a scomparsa in feltro nella tinta base del tappeto.  
Polyamide rug soft nylon shiny with digital printing, different graphics available. Hidden felt border matching with the color of the rug.



RAINBOW  
S120X900 200 x 300 cm  
S141X575 160 x 240 cm  
S142X1800 300 x 400 cm  
S120 Custom size X150 mq.

RIFLESSI  
S164 Custom size X130 mq.€

TAPPETI - RUGS - RIFLESSI - RAINBOW

STAMPA DIGITALE - DIGITAL PRINTING

SCEGLI IL TUO DISEGNO - CHOOSE YOUR DESIGN

Alcuni esempi di stampa dal nostro catalogo carte da parati e quadri.  
Some graphics from our wallpaper catalogue and painting graphics.



Giardino WP03087



Energy WP07020



Kilty WP08174



Decor WP03002



Dream WP08035



Tatain WP04046



Geometric WP07008



Geometric WP07004



Jungle WP03027



White Rose



Roses WP03037



Fiammingo WP03036



Black Berry WP08176



Miss WP07033



Shibori WP01082

PASSPARTOUT - FURNITURE COLLECTION

COMO e SIDE Comodini\_Bedside tables

pag. 23 - 89 - 111

pag. 3

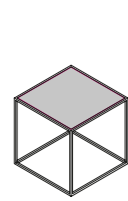

COMO  
PACO40X154  
L 40 P 40 H 40 cm

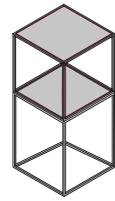

SIDE 30  
PACO30X154  
L 30 P 30 H 60 cm

Complementi in filo di metallo spessore 10x10 mm con ripiani incassati montati con nessun sistema di fissaggio a vista. Verniciatura epossidica antracite (manganese).

Metallic furniture thickness 10x10 mm with installed shelves with no fixing system at sight. Epoxy powder coating anthracite (manganese).

SQUARE Tavolini quadrati\_Coffee tables square

pag. 65 - 135

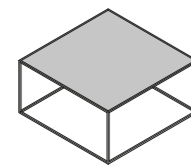

SQUARE  
PATS80X238  
L 80 P 80 H 40 cm

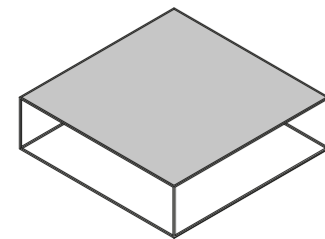

SQUARE  
PATS140X416  
L 140 P 140 H 40 cm

ROUND Tavolini rotondi\_Coffee tables rounder

pag. 43 - 60 - 89 - 103 - 138



ROUND  
PATR40X189  
Ø 40 H 40 cm

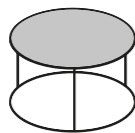

ROUND  
PATR80X239  
Ø 80 H 40 cm

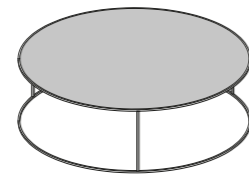

ROUND  
PATR120X364  
Ø 120 H 40 cm

BISTRÒ Tavoli\_Tables

pag. 199



BISTRÒ  
PATB78X280  
Ø 70 H 78 cm

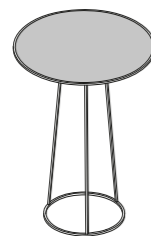

BISTRÒ  
PATB100X300  
Ø 70 H 100 cm

LIBRERIA 80 e 120 Librerie\_Bookcases

pag. 25 - 29 - 49 - 57

MADIA 80\_Cupboard

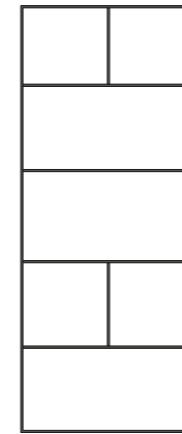

LIBRERIA 80  
PALI80X690  
L 80 P 30 H 200 cm

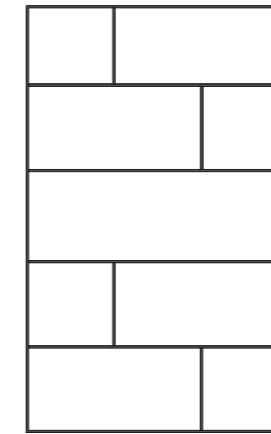

LIBRERIA 120  
PALI120X795  
L 120 P 30 H 200 cm

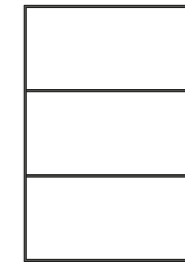

MADIA 80  
PALI30X384  
L 80 P 30 H 120 cm

SCRIVANIA\_Desk

pag. 6 - 21 - 113

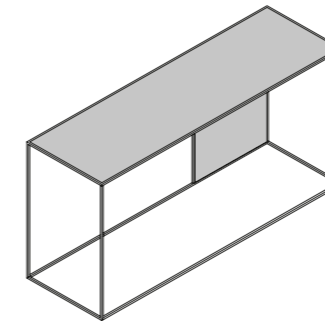

DESK  
PASC160X470  
L 160 P 50 H 80 cm

MAGIC

pag. 7 - 21 - 25

Cassetto magnetico\_Magnetic drawer

Cassetto posizionabile a piacere sotto tutti i piani della collezione.

Drawer to be placed as you prefer under all the levels of the collection.

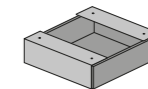

MAGIC  
PACM30X80  
L 30 P 27 H 7 cm

SEGNO Mensola\_Shelves

pag. 15 - 199

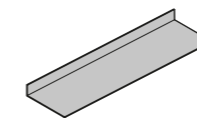

SEGNO  
PAME100X138  
L 100 P 24 H 6 cm

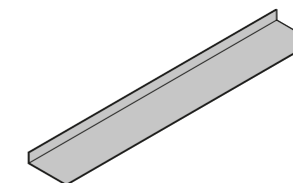

SEGNO  
PAME160X152  
L 160 P 24 H 6 cm

MIRTO Mensola\_Shelves

pag. 192 - 195

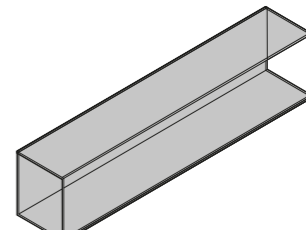

MIRTO  
PAMI160X445  
L 160 P 30 H 40 cm

AMBRELLA pag. 8 - 211

pag. 35 - 115 - 211

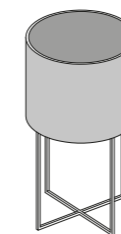

AMBRELLA  
Fioriera Flowerpot  
D184X200 antracite/anthracite  
D184/6X200 golden black  
Ø 40 H 80 cm

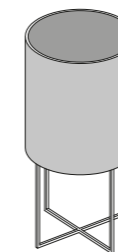

AMBRELLA  
Fioriera - Portaombrelli Umbrella stand - Flowerpot  
D188X220 antracite/anthracite  
D188/6X220 golden black  
Ø 40 H 100 cm

Cod. /X Antracite Anthracite  
Cod. /6X Golden black

PASSPARTOUT - FURNITURE COLLECTION

TULIP pag. 38

TULIP VASE pag. 48 - 160

CONSOLLE 60 TULIP pag. 32

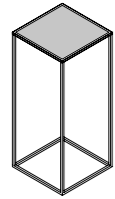

TULIP  
PATU30X145  
L 30 P 30 H 70 cm

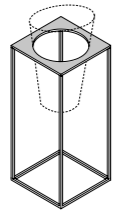

TULIP VASE  
PATV30X155  
L 30 P 30 H 70 cm

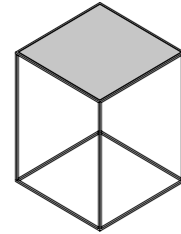

CONSOLLE 60 TULIP  
PATU60X240  
L 60 P 60 H 78 cm

TULIP 80 pag. 34 - 186

TULIP 120 pag. 40

TULIP VASE 100 pag. 39

TULIP VASE 120

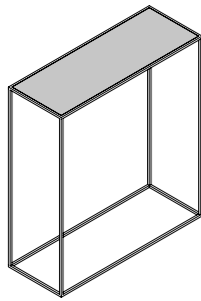

TULIP 80  
PATU80X168  
L 80 P 30 H 90 cm

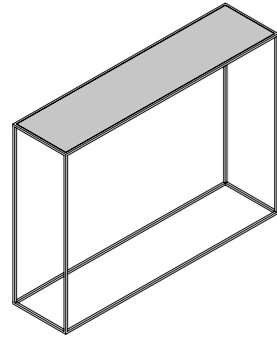

TULIP 120  
PATU120X360  
L 120 P 30 H 90 cm

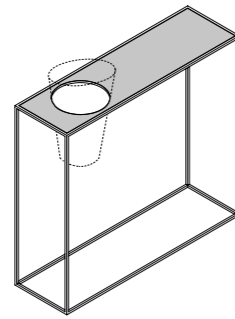

TULIP VASE 100  
PATV100X265  
L 100 P 30 H 90 cm

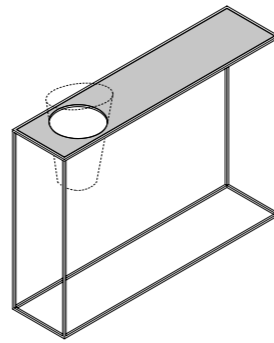

TULIP VASE 120  
PATV120X380  
L 120 P 30 H 90 cm

STEP VASE 120 pag. 159 - 195

CONSOLLE RIP 120

CONSOLLE RIP VASE 120

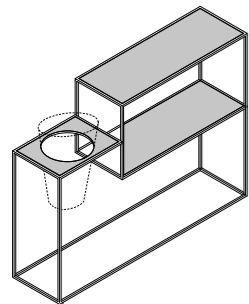

STEP VASE 120  
PAST120X490  
L 120 P 30 H 90 cm

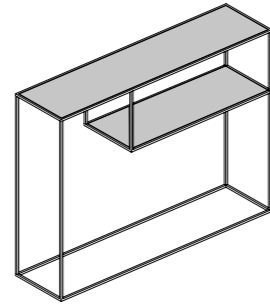

CONSOLLE RIP 120  
PACR120X440  
L 120 P 30 H 90 cm

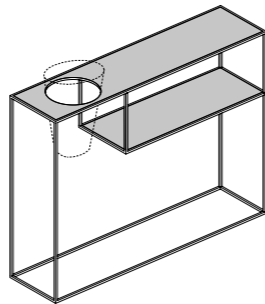

CONSOLLE RIP VASE 120  
PACV120X460  
L 120 P 30 H 90 cm

Vasi abbinabili alle consolle. Combinable vases.



Vaso in vetro trasparente. Transparent glass vase.  
COVER  
C20AX18  
Ø 13/26 H 26 cm



Vaso in ceramica nero opaco. Matt black ceramic vase.  
NICE  
Q111/3X72  
Ø 25 H 52 cm

GRUCCIA pag. 187 - 197  
Appendiabiti\_Clothes hangers

UP pag. 205  
Appendiabiti\_Clothes hangers

GAMANI pag. 185  
Porta asciugamani o servetto  
Towel rack or wears clothes

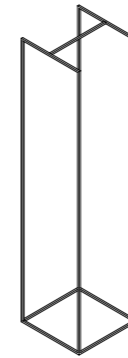

GRUCCIA  
PAGR50X235  
L 50 P 40 H 170 cm



UP  
PAUP25X144  
L 25 P 25 H 170 cm

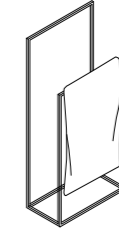

GAMANI  
PAGA50X175  
L 50 P 25 H 90 cm

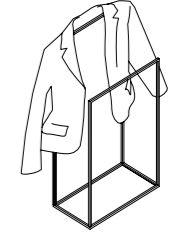

BRAME Specchiera\_Mirror

Specchio fumè. Fumé mirror.

pag. 115 - 186 - 191



BRAME  
PASP60X286  
L 60 H 195 cm

BAGS ROUND Porta valigie\_Luggage case

BAGS CUBE Porta valigie\_Luggage case

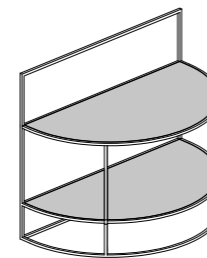

BAGS ROUND  
PABR80X650  
L 80 P 45 H 67 cm

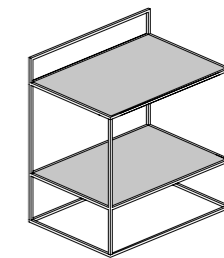

BAGS CUBE  
PABC80X650  
L 80 P 45 H 67 cm



MISS MARY - FURNITURE COLLECTION

Tutti i mobili possono essere realizzati a misura nello stesso prezzo della media a cm  
All the furniture can be realized in a custom size maintaining the same price.

LAMPO Madie\_Sideboards

pag. 213

Ripiano in vetro temperato sp. 12 mm.  
Tempered glass counter thk 12 mm.

Mobili laccati in MDF scolpito.  
Tutti i sistemi a vista a scomparsa.

Lacquered furniture MDF carved.  
Open style and hidden style system.

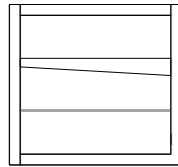

LAMPO  
LA16/149X1400  
L 160 P 40 H 149 cm

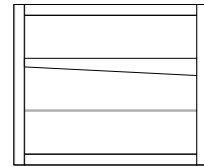

LAMPO  
LA18/149X1800  
L 180 P 40 H 149 cm

Finiture disponibili per tutta la collezione:  
Available finishes for the entire collection:



Laccato lucido  
nei colori a  
richiesta  
Glossy lacquered  
colors upon request



Laccato opaco  
nei colori  
a richiesta  
Matt lacquered  
colors upon request



Golden black



Silver black

BOOK Librerie\_Bookcases

pag. 209 - 218 - 221

Ripiano in vetro temperato sp. 12 mm.  
Ripiano in vetro temperato sp. 12 mm.



BOOK  
BO35/18X950  
L 35 P 22 H 180 cm



BOOK  
BO50/18X1100  
L 50 P 35 H 180 cm

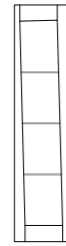

BOOK  
MM50/22X1100  
L 50 P 35 H 220 cm

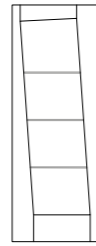

BOOK  
MM80/22X1200  
L 80 P 35 H 220 cm

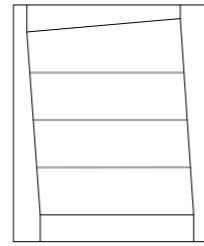

BOOK  
MM18/22X1950  
L 180 P 35 H 220 cm

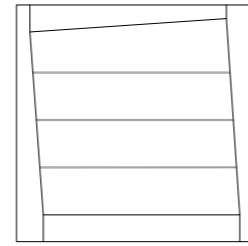

BOOK  
MM22/22X2150  
L 220 P 35 H 220 cm

VALENTINO

Specchio inclinato\_Slanted mirrors

pag. 205 - 207

Specchio fumè.  
Fumé mirror.

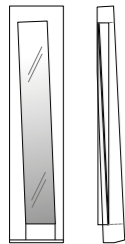

VALENTINO  
VA50/22X950  
L 50 P 22 H 220 cm

LOOK

Specchiere\_Mirrors

pag. 210 - 211

Specchio fumè.  
Fumé mirror.

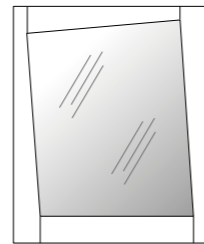

LOOK  
LO18/22X1850  
L 180 P 22 H 220 cm

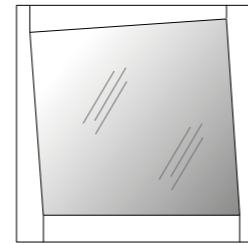

LOOK  
LO22/22X1950  
L 220 P 22 H 220 cm

LINE

Mensole\_Shelves

pag. 216



LINE  
LI16/44X500  
L 160 P 35 H 44 cm



LINE  
LI18/44X600  
L 180 P 35 H 220 cm



LINE  
LI22/44X700  
L 220 P 35 H 44 cm

HALL Contenitori\_Boxes



HALL  
HA18/35X850  
L 180 P 50 H 35 cm



HALL  
HA18/50X900  
L 180 P 35 H 50 cm

CRAZY Contenitori\_Boxes

pag. 223

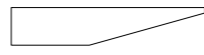

CRAZY  
CR18/35X1000  
L 180 P 50 H 35 cm



CRAZY  
CR27/56X1400  
L 270 P 50 H 56 cm

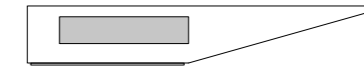

CRAZY  
CR32/56X1500  
L 320 P 50 H 56 cm

TRAVE Contenitori\_Boxes

pag. 230



TRAVE  
TR18/56X700  
L 180 P 50 H 56 cm



TRAVE  
R27/56X800  
L 270 P 50 H 56 cm



TRAVE  
TR32/56X1000  
L 320 P 50 H 56 cm

TRAVE UP Contenitori sospesi\_Suspended boxes



TRAVE UP  
TU18/56X750  
L 180 P 50 H 56 cm



TRAVE UP  
TU27/56X800  
L 270 P 50 H 56 cm



TRAVE UP  
TU32/56X900  
L 320 P 50 H 56 cm

UBIK Comodini\_Bedside tables

pag. 155



UBIK  
UB60/45X200  
L 60 P 60 H 45 cm



UBIK  
UB80/45X250  
L 80 P 60 H 45 cm

BACK Comodino\_Bedside table



BACK  
BA36/47X1300  
L 360 P 40 H 47 cm

MISS MARY - FURNITURE COLLECTION

Tutti i mobili possono essere realizzati a misura nello stesso prezzo della media a cm.  
All the furniture can be realized in a custom size maintaining the same price.

GLORY Tavoli\_Tables

pag. 231

Mobili laccati in MDF scolpito.  
Tutti i sistemi a vista a scomparsa.

Lacquered furniture MDF carved.  
Open style and hidden style system.

Finiture disponibili per tutta la collezione:  
Available finishes for the entire collection:



Laccato lucido  
nei colori a  
richiesta  
Glossy lacquered  
colors upon request

Laccato opaco  
nei colori  
a richiesta  
Matt lacquered  
colors upon request

Golden black

Silver black

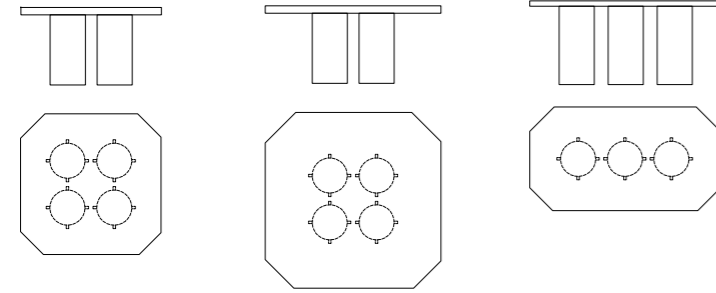

GLORY  
GL12/75X900  
L 120 P 120 H 77 cm

GLORY  
GL15/75X1100  
L 150 P 150 H 77 cm

GLORY  
GL12/16X900  
L 120 P 160 H 82 cm

DOUBLE Tavolino\_Coffee tables

pag. 229

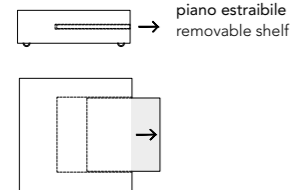

piano estraibile  
removable shelf

DOUBLE  
DO12/35X1200  
L 120 P 120 H 35 cm

SLIDE Tavolino\_Coffee tables

pag. 227

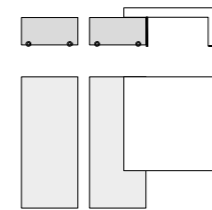

SLIDE  
SL137/41X1400  
L 140 P 137 H 41 cm

MARY Poltroncina e divano\_Armchair and sofa

pag. 49 - 63 - 65 - 142

Colori rivestimento a richiesta.  
Colors on request.



Poltroncina e divano imbottito rivestito in velluto.  
Armchair and sofa upholstered in velvet.



MARY SIT  
MS71/78X465  
L 71 P 62,5 Hs 41,5 H 78 cm

MARY SOFT  
MS167/86VX780 (velluto - velvet)  
L 167 P 63 Hs 41,5 H 78 cm



MARY CHAIR  
MC71/86X450  
L 71 P 62,5 Hs 49,5 H 86 cm

MARY SOFA  
MS167/78VX800 (velluto - velvet)  
L 167 P 63 Hs 49,5 H 86 cm

COMPLEMENTI - ACCESSORY

NAPPE Pouf

pag. 32 - 186 - 201

Pouf in gres porcellanato finitura grigio scuro.  
Pouf in porcelain stoneware dark grey finish.

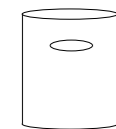

NAPPE  
Q497X90  
H 41 Ø 37 cm

PORTO Vassoio\_Tray

pag. 235

Vassoio in MDF laccato nero opaco e interno metallo verniciato.  
MDF tray lacquered matt black with inside metal lacquered.

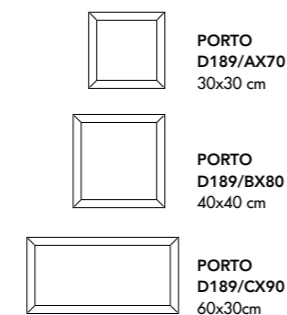

SHOP.ADRIANIEROSI.COM

Special thanks to:

Photo Stylist Studio Emozioni - TV Silvana Bicego

Furniture Montbel San Giacomo Italiana Divani Ronda Design Idea Group

Freetime Nardini Distillerie

Adriani & Rossi Edizioni si riserva la facoltà di modificare in qualunque momento e senza preavviso, le caratteristiche tecniche degli elementi usati nel presente catalogo. Alcuni accessori presenti nelle immagini fotografiche non sono prodotti da Adriani & Rossi Edizioni. Si prega di far riferimento al listino prezzi. Adriani & Rossi Edizioni si riserva inoltre il diritto di apportare ai propri prodotti quelle modifiche che riterrà necessarie o utili al fine di migliorarli senza pregiudicarne le caratteristiche essenziali. È vietata ogni riproduzione totale e parziale in Italia e all'estero. / Adriani & Rossi Edizioni is entitled to modify the technical features of the elements used in this catalogue at any time and without giving notice. Some of the accessories shown in the photographs are not produced by Adriani & Rossi Edizioni. Please refer to the price list. Adriani & Rossi Edizioni is entitled to make any modifications to its products that it deems necessary or useful to improve them without changing their essential features. Any total or partial reproduction in Italy or abroad is prohibited.